

75
July
1989

elektor **INDIA**

170
Rs. 10.00

electronics

THE MAGAZINE FOR PROFESSIONALS

MIDI KEYBOARD



Sunder Singh

- Plucking the fruits of robot
- In-circuit transistor tester
- 8-digit frequency meter
- CMOS switches for audio applications
- Semiconductor diodes

Publisher: C.R. Chandarana
Editor: Surendra Iyer
Circulation / Advertising: J. Dhas
Production: C.N. Mithagari

Address:
ELEKTOR ELECTRONICS PVT. LTD.
52, C Proctor Road, Bombay-400 007 INDIA
Telex: (011) 76661 ELEK IN

OVERSEAS EDITIONS

Elektor Electronics
(Publishing)

Down House, Broomhill Road,
LONDON SW18 4JQ

Editor: Len Seymour

Publitrone Publicacoes Tecnicas Ltda
Av Ipiranga 100, 9º andar
CEP 01040 Sao Paulo - Brazil
Editor: Juliano Barsali

Elektor sarl
Route Nationale, Le Seau; B.P. 53
59270 Bailleul - France
Editors: D R S Meyer;
G C P Raedersdorf

Elektor Verlag GmbH
Süsterfeld-Straße 25
5100 Aachen - West Germany
Editor: E J A Krempelsauer

Elektor EPE
Karaiskaki 14
16673 Voula - Athens - Greece
Editor: E Xanthoulis

Elektuur B.V.
Peter Treckpoelstraat 2-4
6191 VK Beek - the Netherlands
Editor: P E L Kersemakers

Electro-shop
35 Nassem Plaza
Lasbella Chawk
Karachi 5 - Pakistan
Manager: Zain Ahmed
Ferreira & Bento Lda.
R.D. Estefânia, 31-1º
1000 Lisboa-Portugal
Editor: Jeremias Sequeira

Ingelek S.A.
Plaza República Ecuador
2-28016 Madrid - Spain
Editor: A M Ferrer

Electronic Press AB
Box 9505
14105 Huddinge - Sweden
Editor: Bill Cedrum

The Circuits are domestic use only. The submission of designs or articles implies permission to the publisher to alter and translate the text and design and to use the contents in other Elektor Publications and activities.

The publishers cannot guarantee to return any material submitted to them. Material must be sent to the Holland address (given above). All drawings, photographs, printed circuit boards and articles published in elektor publications are copyright and may not be reproduced or imitated in whole or part without prior written permission of the publishers.

Patent protection may exist in respect of circuit devices, components etc. described in this magazine.

The publishers do not accept responsibility for failing to identify such patent or other protection.



Printed at : Trupti Offset Bombay - 400 013

Copyright © 1989 Elektuur B.V.

Volume-7, Number-7
July-1989

CONTENTS

Editorial

The mission must succeed 7.07

Special Features

Plucking the fruits of robot 7.11

Application notes

Voice recorder from Texas Instruments 7.43

Components

CMOS switches for audio applications 7.22

Practical filter design (6) 7.32

Semiconductor diodes 7.51

Electroponics

PROJECT: MIDI keyboard controller 7.35

MIDI split control 7.54

MIDI Signal redistribution 7.57

Computers

PROJECT: In line RS 232 monitor 7.48

Test Measurement

PROJECT: 8-digit frequency meter 7.26

PROJECT: In-circuit transistor tester 7.46

Information

Industrial licence and letters of intent 7.59

Electronic News 7.20

Industry News 7.17

Telecom News 7.15

Guide Lines

Corrections 7.73

Classified ads 7.74

Index of advertisers 7.74

THE MISSION MUST SUCCEED

Commissions and committees have been rather too many in the country that the recent constitution of the Telecommunication Commission is likely to be dismissed as one of the so many commissions and nothing more. The country can ill-afford such a cynicism. Or at least, the Telecommunication Commission cannot be bunched with the powerless and purposeless governmental organisations.

That a person like Mr. Sam Pitroda heads the commission and that the commission has been formed not a day sooner than required compels us to look at this commission with a difference.

Elsewhere in this issue, we have dealt with the most basic issues like why telephone services cost too much in this country and why don't we have sufficient number of telephone systems which work efficiently. Often, we notice a widespread tendency to blame the telephone department for all the ills, though it cannot be totally absolved of the blame.

Outdated and overused equipment and cables are certainly the cause of the poor phone services. Most of all, the traditional attitude that telephone is a luxury and cannot be accorded priority in the planning process ensured a primitive slot for telecommunications in India. Undoubtedly, this attitude has changed and there is an awareness that telecommunication services are inseparably linked to the economy and progress of the nation.

Even if one looks at telecommunications purely in a commercial angle, still it deserves a special treatment. Telecom services and equipment in India are worth more than Rs. 4000 crores. International trade is a crucial factor nurturing the health of a country and international telecommunication is a part of it. India, like any other nation simply cannot remain isolated in the globalisation of communication.

It may be reasonable to assume that politicians, policy makers and planners have come to realise the potential of telecommunication and that they do not need much more prodding.

As an expert has sounded a caution, the requirements of telecommunication in India are somewhat unique and variegated. The needs vary according to the segment like international trade, national business, civic life, rural areas and so on. Since these segments represent distinctly different markets, the strategies to be adopted should also be such as to suit each segment. There can be no single, uniform prescription to the ailments of the country in telecommunication.

Front cover

Perhaps the major feature of the MIDI-compatible keyboard controller published in this issue is that it can be used with practically any existing keyboard, whether salvaged from a discarded instrument, or still in use in a piano, organ, or non-MIDI synthesizer. It supports up to 96 keys covering 8 octaves.

CMOS SWITCHES FOR AUDIO APPLICATIONS

T. Giffard

When about ten years ago the first analogue CMOS switches and multiplexers reached the audio components market, many audio enthusiasts believed that there was at last an end in sight to the use of expensive relays and other electromechanical elements to control volume and rumble or switch signal sources and functions. Unfortunately, the low speeds, high, non-linear on-resistance and level of crosstalk associated with the new devices soon put an end to these expectations. Over the past few years their quality is claimed to have improved considerably. These claims have been tested in our laboratory through a number of CMOS switches and circuits.

We will commence by taking from the numerous parameters of CMOS switches those that are of importance to audio designers, namely:

- resistance of the closed switch (R_{on} in Ω);
- analogue voltage range (U_a in V);
- R_{on} as a function of U_a (in %);
- consistency of R_{on} over a number of switches (in %);
- insulation in off condition (in dB);
- crosstalk between a closed and an open switch (C_r in dB);
- rise time (T_{on} in ns);
- drop-out time (T_{off} in ns).

The first four of these parameters are particularly important for the linearity of the audio circuit; the next two, for the crosstalk performance, and the rise time is of vital importance in some applications as we shall see later.

Topology of CMOS switches

CMOS switches may be used for three specific functions: (1) the selection of the signal source; (2) switching of auxiliary functions, such as changing filter characteristics or altering the volume, in the same way as a rotary switch; and (3) as quasi-digital volume control.

In (1) and (2) the basic circuit of the switch is almost always the same: it serves to interrupt the signal path in a fairly simple manner. For instance, in

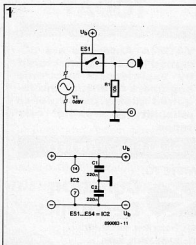

Fig. 1. This simple circuit is perfectly satisfactory for many audio applications.

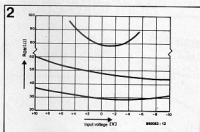

Fig. 2. On resistance vs supply voltage curves.

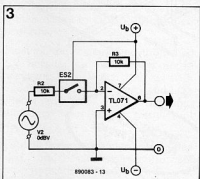

Fig. 3. An improved version of Fig. 1 for more exacting requirements.

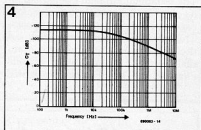

Fig. 4. Typical channel separation vs frequency characteristic.

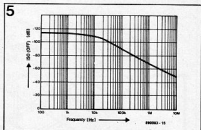

Fig. 5. Typical crosstalk vs frequency characteristic.

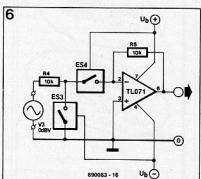

Fig. 6. An improved version of Fig. 3 for the most demanding applications.

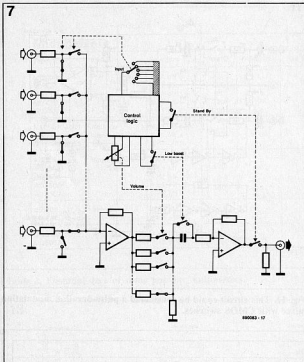

Fig. 7. Schematic diagram of a DC-controlled preamplifier.

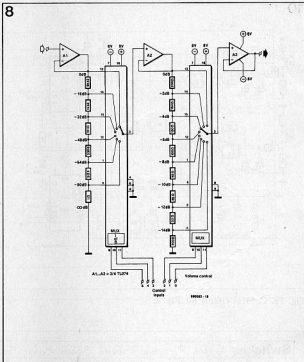

Fig. 8. Traditional high-quality electronic volume control covering a range of 96 dB in 2 dB steps.

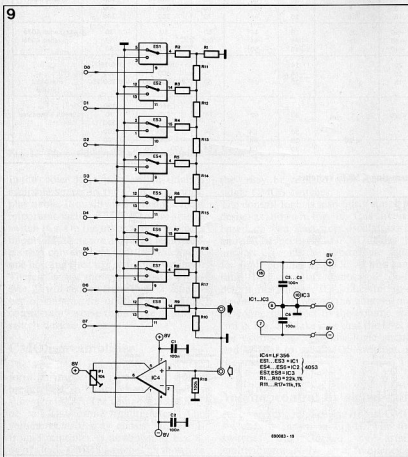

Fig. 9. Alternative to Fig. 8 with electronic step control via single CMOS switches.

Fig. 1 the popular CD4066 has been inserted into the signal path to serve as a relay or electromechanical switch. The 10 kΩ load resistance is part of a general audio network. Tests of this circuit were reasonably satisfactory in spite of the dependence of R_{on} on the signal level and supply voltage (typical curves of the former are given in Fig. 2). The relatively large value of R_{on} and that of the ratio $R_{on}:R_1$ caused some distortion of the signal.

The tests also showed that CMOS switches, even from the same manufacturer, vary quite a lot from one to another.

The overall distortion varied from -74 dB to -84 dB (<0.02%), depending on the IC, at a supply voltage of ± 7.5 V and a signal level of 1 V r.m.s. The distortion remained within the values indicated when the signal level was increased, but increased sharply when the supply voltage was reduced.

This IC can not be recommended for use in exacting applications, but for normal purposes it is perfectly satisfactory.

The fact that the non-linear drop across the switch at high signal levels was the cause of much of the distortion led us to the circuit in Fig. 3. This has a much better distortion figure: -87 dB (0.0045%) at a supply voltage of ± 5 V. When the supply voltage was increased to ± 7.5 V, the distortion could no longer be measured accurately. This would mean that this circuit is suitable for even the most exacting audio requirements, were it not for the channel

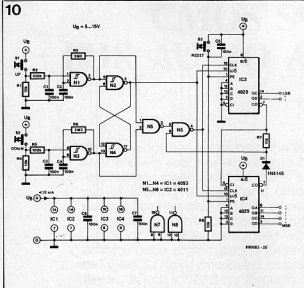

Fig. 10. Control circuit for Fig. 8.

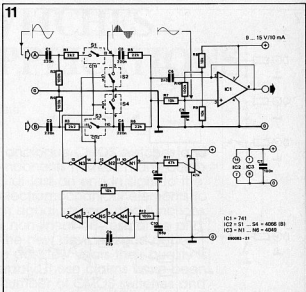

Fig. 11. This circuit could be considered a pulse-duration modulation mixer with CMOS switches.

Switches ¹ 1, 0.5 MHz ² 1, 25 MHz ³ 900 kHz ⁴ 1 MHz ⁵ 1 kHz ⁶ 100 kHz											
Type	Maker	Functions	Ron [Ω]	Δ Ron [%]	RonMatch[%]	Uass [V]	ISOeff [dB]	CT [dB]	Ton [ns]	Toff [ns]	Remarks
SW01/02	PMI	4 × on/4 × on	85	7	4	26	58 ¹	70	300	200	—
SW05		2 × off	45	5	5	26	62 ¹	76	325	210	—
SW06		4 × on	50	5	5	26	58 ¹	70	340	200	Disable input
SW201/202		4 × on/4 × on	60	5	5	26	58 ¹	70	340	200	—
SW7510/11		4 × on/4 × off	60	15	1.5	26	66 ¹	70	350	260	—
MM74HC4016	NS	4 × on	20	~80	25	15	44 ⁴	50	10	30	upgraded 4016
MM74HC4066		4 × off	50	~65	25	15	44 ⁴	50 ²	13	38	upgraded 4066
CD4066		4 × on	80	~40	6	15	50 ²	50 ²	50	50	—
AD7510/11	AD	4 × on/4 × off	75	20	1	24	*	*	180/350	350/180	—
AD7512		2 × change-over	75	20	1	24	*	*	300	300	—
AD7590(91/9201)		4 × on/4 × off/ 2 × change-over	60	15	3	20	85 ⁵	56	240/400/350	400/250/350	with input Latches
DG300-303	MAXIM	see Fig. 12	30	< 20	*	30	62 ¹	74 ¹	150	130	CMOS compatible
DG304-307			110	70							
DG381-390			150	300							
IHS040-45			400	200							
IHS048-51		40	*	< 20	28	54	54	400	200	200	—
IHS140-45		50	*	6	30	54	54	100...200	125...75	—	—

Table 1. Essential data of some popular and interesting CMOS switches.

separation and crosstalk (-84 dB at 1 kHz; -60 dB at 20 kHz). Although the measured figures would be satisfactory for mass-produced equipment, they are not for good-quality apparatus. Typical characteristics of these parameters are given in Fig. 4 and Fig. 5. It may also be considered a drawback of the circuit that the opamp inverts the signal.

A further improvement of the circuit is shown in Fig. 6. This has an additional CMOS switch that short-circuits the signal when the switch in the signal path is open. The control signals for the two switches must therefore be in antiphase. The circuit shows an improvement in crosstalk and channel separation to -84 dB at 20 kHz. At this frequency the layout of the PCB makes a greater contribution to the distortion, as we have found many times in the design of audio equipment.

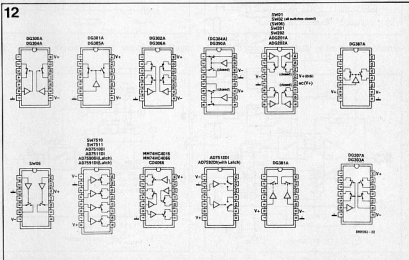

Fig. 12. Pin-out diagrams of the CMOS switches in Table 1.

Multiplexers

Type	Maker	Functions	Ron (Ω)	Δ Ron (%)	Ron Match (%)	V _{max} (V)	ISO _{off} (dB)	CT (dB)	T _{ux} (μs)	Remarks								
MUX08	PMI	1 x 1 off 8	220	1	7	25.4	60	70	1.8	—								
MYX24		2 x 1 off 4	220	1	7	25.4	60	76	1.8	—								
MUX16		1 x 1 off 16	290	1.5	7	26	66	75	1.7	—								
MUX28		2 x 1 off 8	290	1.5	7	26	66	75	1.7	—								
MUX88		1 x 1 off 8	220	1.5	12	36	88	98	1.8	3-bit binary; enable input								
MM74HC4051 MM74HC4052 MM74HC4053	National Semiconductor	1 x 1 off 8	112	~ 60	~ 15	11	*	*	*	*: no data inhibit input bi-directional								
AD7501 AD7502		Analog Devices								1 x 1 off 8	170	20	4	25	*	*	1.6	enable input enable input enable; no data enable input *: no data
AD7503 AD7506 AD7507										1 x 1 off 8								300
IH6108 IH6208	Intersil		1 x 1 off 8	300	20	*	28	60	*	1.2								
DG508A DG509A		MAXIM	1 x 1 off 8								130	> 24	6	30	68	*	0.8	

Table 2. Essential data of some popular multiplexers.

13

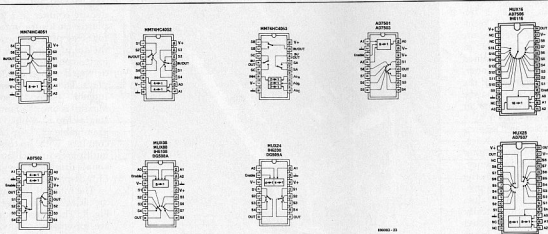

Fig. 13. Pin-out diagrams of the multiplexers in Table 2.

In the choice of a type of switch, quality, available space on the PCB, and price, play a role. If quality is deemed the most important factor, it is best to use single-switch ICs. On the other hand, if price is important, there are analogue multiplexers that contain a number of switches in one housing (just like stepping switches). These ICs save money and space. However, as will be seen from Table 2, a number of parameters of these devices are considerably worse than those of single-switch devices.

CMOS preamplifier

The circuit of Fig. 6 may be used to form an important part of a complete preamplifier, a basic design of which is shown in Fig. 7. The source selector may be a 2x1-form-8 multiplexer. The volume control may consist of two 1-from-8 multiplexers as shown in Fig. 8, or of single CMOS switches as shown in Fig. 9. If auxiliary functions, for instance, bass lift or stand by, are required,

they may be realized with the aid of single CMOS switches.

The control logic is also fairly simple to design as shown in Fig. 10. This circuit is based on two start-stop oscillators, N_1 and N_2 respectively. NAND gates N_5 and N_6 generate the appropriate signal for 6-bit counter ICs-IC₆. At the same time, the state of monostable N_2 - N_4 determines whether IC₃ will count up or down. The outputs of the counter may be connected direct to the volume control in Fig. 8. Make sure that the level of the control signal to the logic circuits and of that to the CMOS switches are the same.

Volume control by signal ratio

An interesting application of fast CMOS switches is shown in Fig. 11. The four switches are clocked by astable multivibrator N_1 - N_6 at a frequency of 100-150 kHz (sampling theory holds that the clock frequency must be at least

twice as high as the highest audio frequency).

Switches S_1 (S_4) and S_2 (S_3) are provided with control voltages that are in antiphase and are, therefore, never open or closed at the same time. The duty cycle is determined by the setting of P_1 .

The 'lumps' of audio signal at the output of the switches are fed to IC₁. This opamp serves as a low-pass filter — (for removing the clock signal); as an integrator (for synthesizing the lumps of audio signal); and as an impedance converter.

The circuit as shown receives two audio signals whose attenuation is inversely proportional to their loudness: the louder channel A, the softer channel B. Many variations may be applied to the circuit without affecting the original audio signal: one channel may be omitted; P_1 may be replaced by the circuits in Fig. 8 and Fig. 10; and others that we will leave to the reader's ingenuity.

8-DIGIT FREQUENCY METER

by T. Giffard

A state-of-the-art frequency meter module is presented that has an 8-digit, 7-segment LED indication, a resolution of 10 Hz, and accepts input frequencies of up to 3.5 MHz. Its presetting facility makes this simple-to-build module ideal for incorporation in a radio receiver.

The module is based on two ICM7217IPL CMOS presetable up/down counters. Two of these chips are cascaded to obtain an 8-digit read-out on common-anode 7-segment LED displays.

The counter's presetting facility makes it eminently suitable for use as a frequency read-out in receivers, since the intermediate frequency (e.g., 455 kHz or 9 MHz, can be programmed as an offset. In this manner, the output frequency of the local oscillator (L.O.) may be measured by the counter module, when driven by a suitable prescaler. Depending on whether the L.O. frequency is lower or higher than the received frequency, the IF offset is divided by the prescale ratio and then programmed as a preset value, which is automatically added to, or subtracted from, the module's input frequency to ensure that the received frequency is shown on the display.

An example might help to illustrate the above procedure. A super-heterodyne VHF FM broadcast receiver has an intermediate frequency of 10.7 MHz. The L.O. frequency is higher than the received frequency. Assuming that the receiver is tuned to a station at 100.0 MHz, the L.O. generates 110.7 MHz. This signal is applied to a divide-by-100 prescaler, which drives the frequency meter module. To ensure that the display reads 100 MHz, the counter must be programmed for an IF offset of 10.7 MHz/100=107 kHz. Since the counter will normally count up, it must be set to a negative offset, the one's complement to calculate as

10 000 000 - 0 107 000 = 09 893 000.
shift right (10 Hz); MSD borrow;
preset = 99 989 300

The counter module has an up/down input and a separate, but optional, circuit for programming the offset. Resolution

and gating times are simple to change, if desired. The maximum input frequency of the counter module is about 3.5 MHz at a sensitivity of 60 mV_{rms}.

The counter chip

The ICM7217IPL is a CMOS decade counter in a 28-pin plastic enclosure, intended for being programmed with the aid of switches or fixed logic configurations, and driving common-anode displays. The device from GE-Intersil (second source: Maxim) is one of a family of single-chip 4-bit programmable up/down counters with an on-chip multiplex scan oscillator for simple driving of 7-segment LED displays.

The internal structure of the ICM7217 is given in Fig. 1. Three main outputs are provided: CARRY/BORROW for cascading with further 4-bit counters, ZERO which indicates when counter state zero (0000) is

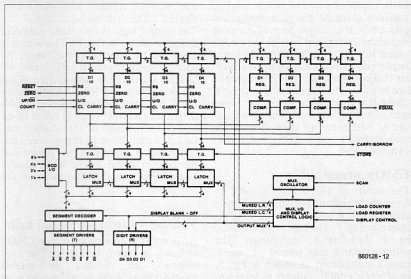
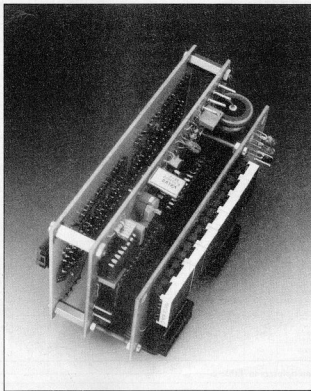

Fig. 1. Block diagram of the ICM7117 (courtesy GE-Intersil).

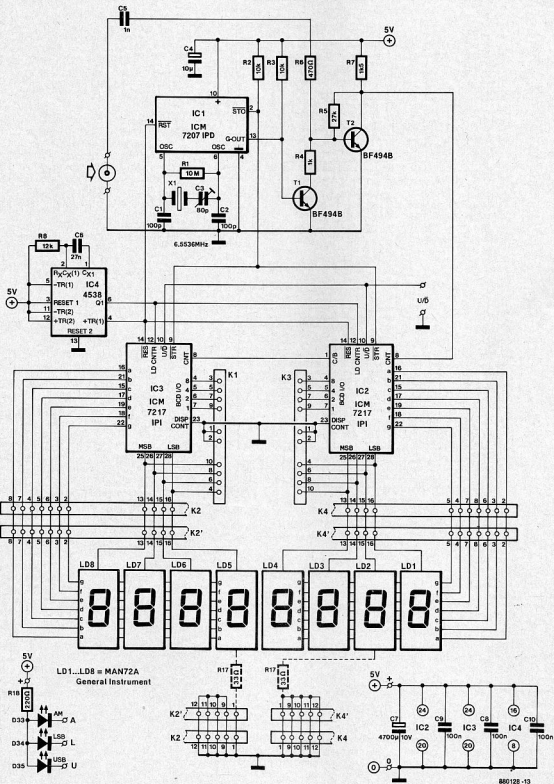

Fig. 2. Circuit diagram of the presetable 8-digit counter module with up/down input and LED read-out.

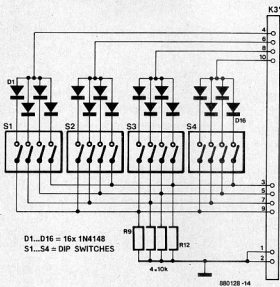

Fig. 3. Circuit diagram of the optional preset unit.

reached, and EQUAL which indicates when the current counter state equals the value loaded into the internal register via the BCD I/O pins. The three outputs and the BCD port are TTL-compatible and internally multiplexed. Output CARRY/BORROW goes high when the counter is clocked from 9999 to 0000 when counting up (input U/D logic high), or from 0000 to 9999 when counting down (input U/D logic low). The Schmitt-trigger at the COUNT input provides hysteresis to prevent double clocking on slow rising edges.

The counter contents are transferred to the multiplexed 7-segment and BCD outputs when input STORE is pulled low. A

low level at the RESET input causes the counter to be asynchronously reset to 0000.

As already noted, the BCD port can function as an input or an output. These functions are selected with the logic levels applied to the three-level LOAD COUNTER (LD) and LOAD REGISTER (LR) inputs. When both are open, the BCD port provides the multiplexed BCD display selection signals, scanning from MSD (most-significant display) to LSD (least-significant display). When either LR or LC is taken high, the BCD port is turned into a 4-bit input for loading the counter (LC) or register (LR) data. Since the ICM7217PI is

designed to drive common-anode displays, the levels applied to, or provided by, the BCD port are 'high true'.

When input LR is made low, the BCD I/O lines are switched to the high-impedance state, and the digit and segment drivers are turned off. The counting operation continues, however, and the remaining input and output functions operate normally. The displays are normally switched off with the aid of input LR to reduce power consumption during stand-by conditions.

The on-board multiplex scan oscillator controls the internal timing of the ICM7217. The nominal oscillation frequency of 2.5 kHz may be reduced by connecting a capacitor between input SCAN and the positive supply line. The oscillator output signal has a relatively low duty factor to delay the digit driver outputs and thus prevent 'ghosting' effects on the displays.

The digit and segment drivers on board the ICM7217 are capable of directly driving common-anode 7-segment LED displays at a peak segment current of 40 mA. At a duty factor of 0.25, this corresponds to 10 mA per segment.

Finally, the DISPLAY CONTROL input recognizes 3 logic levels. When it is logic high, the display segments are inhibited. When it is logic low, the leading zero blanking feature is turned off. Displays on with leading zero suppression is achieved by leaving the input open.

Practical circuit

As shown in the circuit diagram of Fig. 2, a pair of ICM7217PIs is used in conjunction with a central timing generator type ICM7207IPD (IC1). This chip controls the gating of the input signal with the aid of an external quartz crystal, X1, inverter T1 and input amplifier T2. In addition, the ICM7207IPD provides the STORE and RESET signal for the counter chips, IC2 and IC3. Although the STORE output of the ICM7207IPD is of the open-drain type, and the associated inputs of the ICM7217s have 75 μ A pull-up resistors, an external pull-up resistor R2, is fitted to ensure immunity to noise. The U/D and RESET inputs also have internal pull-up resistors, and may, therefore, be left open for normal operation as an up-counter. The block diagram of the ICM7207 is given in Fig. 4.

Monostable IC4 enables the counter to load the preset word. The LOAD COUNTER pulse is delayed with respect to the RESET pulse because the counter can only be preset with data other than 0000 when RESET is inactive.

The preset frequency is set with two blocks of 4-way DIP switch blocks. The circuit diagrams of these (optional) units are given in Fig. 3. BCD thumbwheel switches may be used as a more ergonomic alternative to the DIP switches. Alternatively, wire links may be used if the counter works with one, fixed, preset frequency.

The BCD port lines and the scanning

digit selection signals are available on K_1 and K_3 for connecting to the preset unit.

A few suggestions are given for those who want to experiment with the circuit. The duration of the count window may be reduced from 100 ms to 10 ms by tying pin 11 of the ICM7107IPD (RANGE CONTROL) to the positive supply line. This modification results in a corresponding reduction of the counter's resolution, however: with pin 11 at +5 V, this is 100 Hz instead of 10 Hz. In both cases, a good-quality 6.5536 MHz quartz crystal is required: for optimum stability of the read-out, a type with 10 ppm tolerance or better is recommended (most inexpensive computer crystals do not meet this specification).

For high-resolution applications, the duration of the count window may be increased by a factor 10 (100 ms or 1 s) by using an ICM7207A in combination with a 5.24288 MHz quartz crystal. Unfortunately, this is not a standard frequency, so that this crystal will have to be made to order.

Pin 23 of both counter chips is connected to ground, so that leading-zero suppression is not used. As already discussed, this feature may be useful in a number of applications. Where it is required, pin 23 of ICs may be left open to achieve leading-zero suppression on the most-significant display group. Leading-zero suppression of the full 8-digit display may be realized by driving the DISPLAY CONTROL input pin of the LS group driver, IC₂, with the collector signal of a n-p-n transistor whose base is driven by the ZERO output of the MS group driver, IC₃. In a number of cases, it may be possible to omit the two MS displays altogether.

Resistor R_{17} is only required when the module is used without a prescaler. Depending on whether a MHz or kHz indication is required, the resistor lights the decimal point on LD₅ (MHz read-out) or LD₂ (kHz read-out).

Three receiver mode indicators, D₃₃, D₃₄ and D₃₅, are provided on the display board. The LEDs may be controlled from the mode selection switch in the receiver.

Three boards: a compact frequency read-out

The lay-out of the printed-circuit board for the universal counter is given in Fig. 5. The PCB is cut into three to separate the preset unit (at the top), the main counter board (at the centre), and the read-out section (at the bottom). The receiver mode indication board forms a separate unit, which need, however, not be cut from the display board.

Populating the boards is straightforward and requires hardly any comment. It is strongly recommended to use sockets for all integrated circuits, displays and DIP switches. K_2' and K_4' on the display board, and K_2 and K_4 on the main counter board, are 16-way IC sockets with turned pins. These receive 16-way IDC pin-headers fitted at the ends of an approximately 5 cm long flat-ribbon cable. The

Table 1

Switch block	resolution (Hz)	multiplier
S1	1	$\times 10$
	2	
	4	
	8	
S2	1	$\times 10^2$
	2	
	4	
	8	
S3	1	$\times 10^3$
	2	
	4	
	8	
S4	1	$\times 10^4$
	2	
	4	
	8	
S5	1	$\times 10^5$
	2	
	4	
	8	
S6	1	$\times 10^6$
	2	
	4	
	8	
S7	1	$\times 10^7$
	2	
	4	
	8	
S8	1	$\times 10^8$
	2	
	4	
	8	

Example 1:

IF = 455 kHz; $f_{LO} > f_i$; no prescaler; counter mode: UP.
Preset = 99954500
Switches set to 'on':
S3(1) and (4); S4(4); S5(1) and (4); S6(1) and (8); S7(1) and (8); S8(1) and (8).

For $f_{LO} < f_i$:

preset = 45500
DIP switches set to 'on':
S3(1) and (4); S4(1) and (4); S5(4)

Example 2:

IF = 9 MHz; $f_{LO} > f_i$; prescaler +10; counter mode: UP.

Preset = 99100000
DIP switches set to 'on':
S6(1); S7(1) and (8); S8(1) and (8)

For $f_{LO} < f_i$:

preset = 900000
DIP switches set to 'on':
S6(1) and (8)

Example 3:

IF = 10.7 MHz; $f_{LO} > f_i$; prescaler +100; counter mode UP.

Preset = 99989300
DIP switches set to 'on':
S3(1) and (2); S4(1) and (8); S5(8); S6(1) and (8); S7(1) and (8); S8(1) and (8).

For $f_{LO} < f_i$:

DIP switches set to 'on':
S3(1) and (2) and (4); S5(1)

10-way connections between the main counter board and the read-out are made in 10-way flat-ribbon cables.

Pin-headers K_1 and K_3 on the main counter board are fitted at the component

side, and K_1' and K_3' on the preset board at the track side. The pin-headers are connected with IDC sockets pressed on to the ends of an approximately 5 cm long flat-ribbon cable.

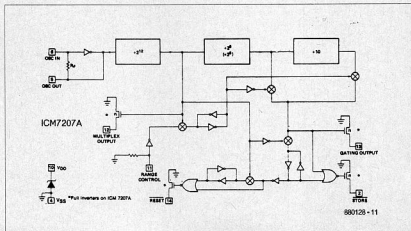

Fig. 4. Internal structure of the ICM7207A timing generator (courtesy GE-Intersil).

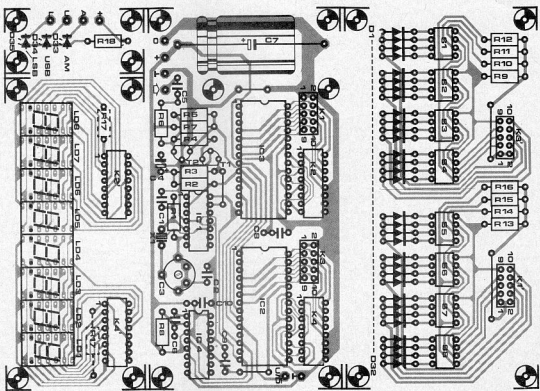
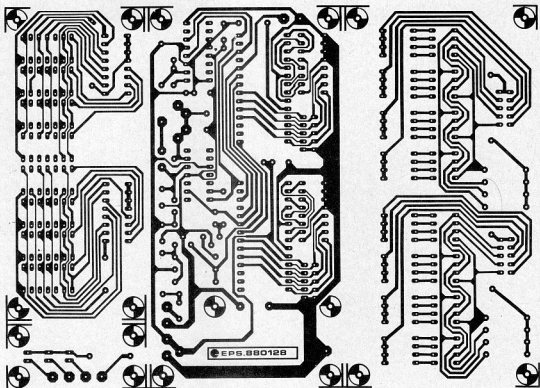

Fig. 5. Track layout and component mounting plan of the printed-circuit board. This is cut into three or four to separate the sub-circuits that together form the frequency read-out.

Parts list

Resistors ($\pm 5\%$):

R1=10M
R2,R3,R9-R15 incl.=10K
R4=1K0
R5=27K
R6=470R
R7=1K5
R8=12K
R17=33R (see text)
R18=220R

Capacitors:

C1,C2=100p
C3=80p trimmer
C4=10 μ ; 25 V; tantalum
C5=1n0
C6=27n
C7=4700 μ ; 10 V
C8,C9,C10=100n

Semiconductors:

D1-D32 incl.=1N4148
D33,D34,D35= LED
IC1=ICM7207IPD (GE-Intersil or Maxim)
IC2;C3=ICM7217IPi or ICM7217IPJ (GE-Intersil or Maxim)
IC4=4538
LD1-LD8 incl.=MAN72A (General Instrument Optoelectronics)
T1,T2=BF494B

Miscellaneous:

K2,K2';K4,K4'= 16-way DIL socket with mating IDC plug.
K1,K1';K3,K3'= 10-way pin header with mating IDC socket.
S1-S8 incl.= 4-way DIL switch block.
X1= 6.5536 MHz quartz crystal.
PCB Type 880128

The construction of the flat-ribbon cables that interconnect the sub-modules is illustrated in Fig. 6. Contrary to what some retailers of specialist tools would have you believe, IDC (insulation displacement) connectors are simple to fit on to flat-ribbon cable with the aid of a carefully operated vice, or even a small hammer and two pieces of wood. Insert the cable between the socket or plug and the associated plastic cap, and align the individual wires with the clip-type connectors. Then close the connector by carefully pressing the cap on to body of the connector. Alternatively, carefully tap the cap in place with the aid of a small hammer. Check the continuity at all pins.

The completed sub-assemblies are then ready for mounting together in a sandwich construction. The read-out board is mounted on top of the main counter board with the aid of three 25 mm long spacers or lengths of M3 threading. Make sure that the soldering connections of the receiver mode LEDs, and those for the nearby terminal posts, do not touch the body of the large electrolytic capacitor, C7, underneath. The preset board is fitted

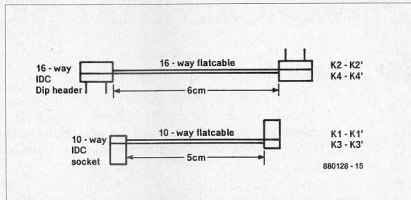

Fig. 6. Construction of the four flat-ribbon cables that interconnect the sandwiched boards.

back-to-back below the main counter board with the aid of 20 mm long PCB spacers with internal threading. The completed three-board assembly is shown in the introductory photograph of this article.

The unit may be installed in a receiver and connected to a regulated and well-decoupled 5 V power supply. In some cases, it may be necessary to screen the module to prevent interference in the receiver. The readability of the displays may be improved by fitting them behind a red bezel.

Calibration is simple if a frequency meter is available: adjust trimmer C3 for 6.5536 MHz measured at pin 5 of the ICM7207. Alternatively, tune the receiver for zero-beat against a frequency reference station, and adjust the trimmer until the correct received frequency is displayed.

Sensitivity of the prototype was 35 mV_{rms} over 200 kHz to 1 MHz, and 60 mV_{rms} at an input frequency of 3 MHz. Average current consumption with eight displays on (indication: 8x'8'), but the receiver mode LEDs off, was measured at

approximately 450 mA.

Offset programming

Assuming that the counter operates in the UP mode, and that the local oscillator frequency is higher than the received frequency, the required preset value is first converted to its 8-digit one's complement. Next, the corresponding DIP switches are set until the preset appears on the displays. Examples for 455 KHz, 900 kHz (9 MHz with +10 prescaler) and 107 kHz (10.7 MHz with +100 prescaler) are given in Table 1. Always remember that the counter can not handle input frequencies higher than 3.5 MHz, so that the effectively programmed offset is the IF frequency divided by the prescale factor. For most SW and general coverage receivers, a +10 prescaler is suitable; for VHF receivers a +100 prescaler.

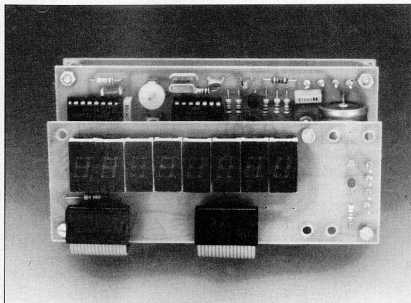

PRACTICAL FILTER DESIGN – PART 6

by H. Baggott

In this sixth part in the series we start our discourse of the tables and characteristics of filters and as first we deal with those pertaining to the Butterworth type because that is the best known and probably also the most often used kind of filter.

The Butterworth filter owes its popularity to a combination of flat amplitude response in the pass band and reasonable roll-off. A drawback is its non-linear phase characteristic.

The roll-off is fairly precisely $6n$ dB per octave, where n is the order of the filter.

The Butterworth filter may be considered a compromise between the Bessel network (moderate roll-off but linear phase response) and the Chebishev filter (steep roll-off, poor phase response and ripple in the pass band). For applications that require a flat pass band and steep roll-off, the Butterworth filter is undoubtedly the best choice.

Table 1 gives the pole locations of

Butterworth filters of the second to the tenth order. These data enable the ready computation of filters with the aid of formulas given in earlier parts in this series.

Butterworth tables

The dimensioning of filters becomes much simpler with the aid of Tables 2 to 5, which give component values for passive and active filters of the second to the tenth order. The values given always refer to a filter with a cut-off frequency of 1 Hz.

Table 2 gives component values for a passive filter with identical source and output impedances. The component identifications at the top of the table correspond to those in the diagrams above the table and those at the bottom of the table correspond to the diagrams below the table.

Table 3 gives the component values for a passive filter with negligible source impedance.

Tables 4 and 5 give the component values for active filters with a single feedback path. Table 4 deals with second- and third-order sections. If, for instance, you want to design a seventh-order filter, you take two

second-order and one third-order section and connect them in tandem.

It is also possible, as we have seen in Part 3, to use only second-order sections and, in the case of odd-order filters, add a passive RC network. The data for this are shown in Table 5. This table is given merely to illustrate the alternative way. Since in the majority of cases it is simpler to work with Table 4, Table 5 will not be given for the other filter types in future parts in this series.

Butterworth characteristics

For clarity's sake, the characteristics given in this article deviate slightly from those given as examples in Part 2. For each type of filter we will give three series of characteristics, showing respectively: the gain vs frequency response—Fig. 32; the delay vs frequency response—Fig. 33; and the step vs time response—Fig. 34. The phase response is not given because this would not divulge all that much on a logarithmic scale. In any case, the phase linearity is easily deduced from Fig. 33, since linearity corresponds to a constant delay time at

n	real part - σ	imaginary part $\pm j\beta$
2	0.70711	0.70711
3	0.5	0.86603
4	0.38268 0.92388	0.92388 0.38268
5	0.30902 0.80902	0.95106 0.58779
6	0.25882 0.70711 0.96593	0.96593 0.70711 0.25882
7	0.22252 0.62349 0.90097	0.97493 0.78183 0.43388
8	0.19509 0.55557 0.83147 0.98079	0.98079 0.83147 0.55557 0.19509
9	0.17365 0.5 0.76604 0.93969	0.98481 0.86603 0.64279 0.34202
10	0.15643 0.45399 0.70711 0.89101 0.98769	0.98769 0.89101 0.70711 0.45399 0.15643

Table 1. Pole locations of Butterworth filters.

n	C1	L1	C2	L2	C3	L3	C4	L4	C5	L5
2	0.2251	0.2251								
3	0.1592	0.3183	0.1592							
4	0.1218	0.2941	0.2941	0.1218						
5	0.09836	0.2576	0.3183	0.2876	0.09836					
6	0.08238	0.2251	0.3076	0.3076	0.2251	0.08238				
7	0.07083	0.1985	0.2868	0.3183	0.2868	0.1985	0.07083			
8	0.0621	0.1768	0.2647	0.3122	0.3122	0.2647	0.1768	0.0621		
9	0.05527	0.1592	0.2438	0.2991	0.3183	0.2991	0.2438	0.1592	0.05527	
10	0.04979	0.1445	0.2251	0.2836	0.3144	0.3144	0.2836	0.2251	0.1445	0.04979
	L1	C1	L2	C2	L3	C3	L4	C4	L5	C5

Table 2. Normalized component values for passive low-pass filters with identical input and output impedances.

n	L1	C1	L2	C2	L3	C3	L4	C4	L5	C5
2	0.2251	0.1126								
3	0.2387	0.2122	0.07985							
4	0.2436	0.251	0.1732	0.06051						
5	0.2459	0.2597	0.22	0.1423	0.04918					
6	0.2472	0.26	0.2472	0.1912	0.1206	0.04119				
7	0.2479	0.2636	0.264	0.2224	0.1679	0.1044	0.03541			
8	0.2484	0.2604	0.2751	0.2432	0.2003	0.1491	0.09193	0.03105		
9	0.2487	0.2592	0.2829	0.2579	0.2234	0.1816	0.1339	0.08204	0.02783	
10	0.249	0.2593	0.2884	0.2685	0.2414	0.2056	0.1656	0.1214	0.07407	0.02489

Table 3. Normalized component values for passive low-pass sections with negligible source impedance.

n	C1	C2	C1	C2	C3
2	0.2251	0.1126			
3			0.5644	0.2215	0.03221
4	0.4159	0.08091			
5	0.1723	0.147			
6	0.515	0.04918	0.279	0.2195	0.06707
7	0.6149	0.04119			
8	0.2251	0.1126			
9	0.1648	0.1537			
10	0.7152	0.03542	0.2437	0.2126	0.07775
11	0.2553	0.09923			
12	0.8158	0.03105			
13	0.2865	0.08842			
14	0.1914	0.1323			
15	0.1623	0.1861			
16	0.9165	0.02764			
17	0.3183	0.07958			
18	0.2078	0.1218	0.2316	0.2112	0.08228
19	1.0174	0.0249			
20	0.3506	0.07225			
21	0.2251	0.1126			
22	0.1786	0.1418			
23	0.1611	0.1572			

Table 4. Normalized component values for active filters with single feedback path.

n	C1	C2	C1
2	0.2251	0.1126	
3	0.3183	0.07958	0.5644
4	0.4159	0.08091	
5	0.1723	0.147	
6	0.515	0.04918	0.279
7	0.6149	0.04119	
8	0.2251	0.1126	
9	0.1648	0.1537	
10	0.7152	0.03542	0.2437
11	0.2553	0.09923	
12	0.8158	0.03105	
13	0.2865	0.08842	
14	0.1914	0.1323	
15	0.1623	0.1861	
16	0.9165	0.02764	
17	0.3183	0.07958	
18	0.2078	0.1218	0.2316
19	1.0174	0.0249	
20	0.3506	0.07225	
21	0.2251	0.1126	
22	0.1786	0.1418	
23	0.1611	0.1572	

Table 5. Normalized component values for filters with single feedback path.

all frequencies. Each of the figures gives the characteristics for a second-, fourth-, sixth-, eighth- and tenth-order section. Those for odd-order filters are assessed from intermediate values; this keeps the number of characteristics to a reasonable level to prevent loss of clarity.

Note that in Fig. 32 for a clear view of the behaviour of the filter just below the cut-off frequency, the scale of the y-axis to the left of 1 Hz has been expanded and is

shown at the left of the drawing. The values of the gain at frequencies above 1 Hz are shown to the right of the drawing.

Two examples

We shall give a couple of worked out examples for each type of filter we deal with to give you the opportunity of learning to use the tables and characteristics quickly and properly.

Example 1.

Design a passive low-pass Butterworth filter with a cut-off frequency of 1600 kHz and a source and output impedance of 50Ω. The attenuation at 3200 kHz must be at least 20 dB.

Solution

First we determine the value of the attenuation at each frequency relative to the normalized frequency of 1 Hz by dividing by the reference frequency by the cut-off frequency:

$$3200 : 1600 = 2.$$

From Fig. 32 we determine which curve affords at least 20 dB attenuation at $f=2$ Hz. and this is found to be for a fourth-order filter the diagram of which is shown in Fig. 35a. Note that a third-order filter just would not do since it would give an attenuation of only 18 dB per octave.

It would also have been possible to deduce the filter from the diagram underneath Table 2. Study this carefully, because once you understand this, the purpose of Table 2 will be clear forever.

All that remains to be done now is to calculate the component values for the given input and output impedance and the cut-off frequency:

$$C = C / (fR)$$

$$L = LR / f$$

The calculations will be found to result in the component values given in the diagrams in Fig. 35b:

Similarly, the values for the components in Fig. 4a are found to be:

$$C_1 = 0.1218 / (1600000 \times 50) = 1.52 \times 10^{-9} = 1.52 \text{ nF}$$

$$L_1 = 0.2941 (50 / 1600000) = 9.19 \times 10^{-6} = 9.19 \mu\text{H}$$

Example 2.

Design an active fifth-order low-pass Butterworth filter with a cut-off frequency of

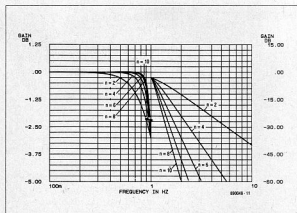

Fig. 32. Gain vs frequency characteristics of a Butterworth filter.

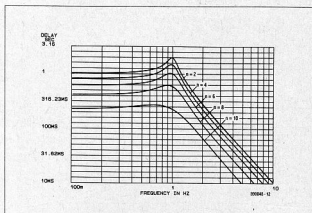

Fig. 33. Delay time vs frequency characteristics of a Butterworth filter.

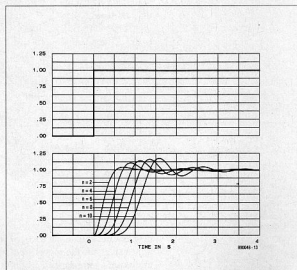

Fig. 34. Step response of a Butterworth filter

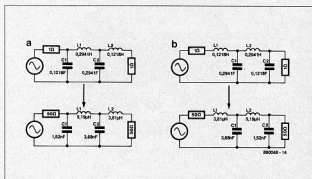
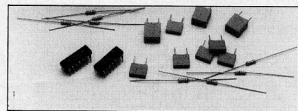

Fig. 35. Two examples of how to dimension a passive Butterworth filter.



5 kHz.

Solution.

This is designed fairly quickly. It is an odd-order filter, so we need a second-order section and a third-order section, as drawn above Table 4. The two sections are connected in tandem, after which the normalized component values read from the table are inserted.

Next, choose a value for the resistors (R in the formulas), say, 4.7 k Ω .

Then calculate with the aid of the formula given in the first example (for C) the 'real' values of the components.

Again, two examples of the calculations:

$$C_1 = 0.515 / (5000 \times 4700) = 21.9 \times 10^{-9} = 21.9 \text{ nF}$$

$$C_2 = 0.04918 / (5000 \times 4700) = 2.09 \times 10^{-9} = 2.09 \text{ nF}$$

This completes our discourse on Butterworth filters. Part 7 will deal with Bessel networks.

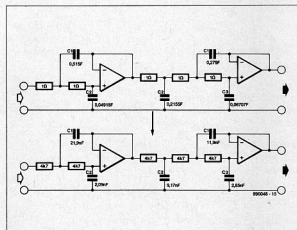
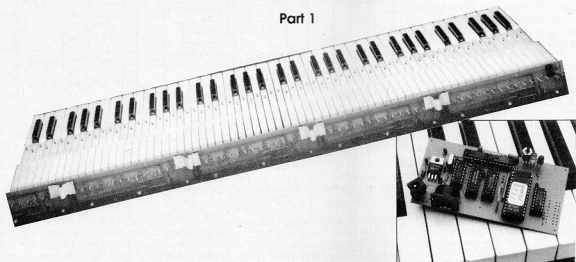

Fig. 36. Illustrating the computation of an active 5th-order filter.

UNIVERSAL MIDI KEYBOARD INTERFACE

Part 1



by D. Doepfer

The feature *par excellence* of the MIDI-compatible keyboard controller described in this article is its ability to be used with practically any existing keyboard, whether salvaged from a discarded musical instrument, or still in function in a piano, organ, or non-MIDI synthesizer.

Soon after the publication of the *Portable MIDI keyboard* (Ref. 1), numerous readers asked us to give further details on the use of the Type E510 MIDI controller in conjunction with full-size keyboards of five and more octaves. This month we meet these requests with the description of a universal MIDI controller board, once again based on the E510, intended for use with many types of musical keyboard.

The maximum number of keys supported by the present design is no fewer than 96, covering 8 octaves. The controller provides the velocity parameter, and supports one-octave transposition as well as instantaneous split-point programming to achieve data distribution between MIDI channels 1 and 2, with any key on the keyboard. The printed-circuit boards have been designed such that they may be used in conjunction with a keyboard having wooden keys and spring- or gold-wire contacts (Kimber-Allen type). Any other type of key or contact is, however, also suitable.

A MIDI keyboard is classified as accessory equipment, not as an instrument, because it is not capable of producing musical sounds. As such, it is used for controlling MIDI synthesizers (*expanders*), or micro-processor based systems running special MIDI programs.

The application range of the present

UNIVERSAL MIDI KEYBOARD

- universal polyphonic MIDI keyboard with a maximum of 8 octaves (96 keys)
- transmits velocity parameter
- 1 instantaneously programmable split-point (channels 1 and 2)
- ± 1 -octave transposition
- simple-to-build circuit
- circuit boards designed for use with spring or wire contacts
- modular keyboard configuration allowed within maximum range of 96 keys: easy implementation of, e.g., 54- or 72-key units
- inputs suitable for driving from contacts other than those on a musical keyboard
- keyboard matched to controller either by software (EPROM contents) or hardware (physical connection of contacts)

circuit is widened further by the fact that the key inputs are suitable for driving from almost anything that represents an electrical contact. We have, therefore, no reservations about calling the circuit *universally applicable*. To mention a few less usual, but technically interesting, ap-

plications: key signals generated by the player interrupting light-beams, or actuation by weight of touch-sensitive areas on a theatre or dance floor.

The velocity parameter is not always required for such applications, and is fairly simple to omit as will be shown later. Other ways of providing the key signals may come to your mind at this stage. At the end of the article, we describe an experimental percussion interface to rouse your interest in finding new applications for the MIDI controller.

We feel sure that the design will please many of our readers, who, no doubt, will have their own follow-up suggestions for, say, a semitone transposition circuit, a sustain pedal, and typical MIDI functions such as program change, pitch bend and access to all 16 available channels. Let us know of such thoughts and ideas and we will respond appropriately.

This two-part article describes the operation, construction and use of the universal MIDI keyboard. Although space did not permit a reiteration of the introduction to the MIDI keyboard, a description of its principles and functions may be found in Ref. 1. This also discusses the way in which a MIDI keyboard controller circuit measures the time between the instant the pole of the key leaves its rest position and the instant it reaches the

work contact. The present keyboard works on the same basis.

Strike the right note with the E510

The Type E510 MIDI controller is without doubt a revolutionary integrated circuit, and has been recognized as such by many readers following the publication of the *Portable MIDI keyboard*. The plastic package with only 16 pins (Fig. 1) contains a programmed control circuit with MIDI keyboard functions normally carried out by a fast microprocessor and one or more peripheral circuits. However, the E510 also has its drawbacks and limitations: it recognizes only one split, while up to 16 can be programmed on many keyboards. Also, the E510 can send data to MIDI channels 1 and 2 only. The velocity parameter can not be geared precisely to the characteristics of the keyboard, or be given the optimum range to suit the average strike force of the user.

Contrary to the single-chip, mask-programmed E510, most microprocessor systems are 'open' which means that they may be programmed or re-programmed to include the above features. The E510, on the other hand, has the advantage of being extremely simple to use in a practical circuit. Acknowledging the fact that the vast majority of musicians working with MIDI equipment are not electronics buffs, a

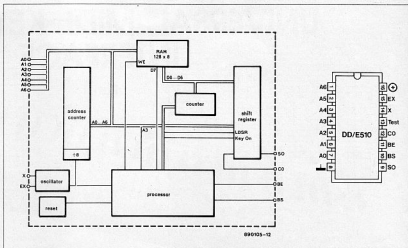

Fig. 1. Pinning and block diagram of the single-chip MIDI keyboard controller Type E510.

simple circuit is a significant factor.

A number of readers have expressed their doubts and reservations about the dynamic range of the E510. These doubts are really not justified. In fact, the velocity processor in the E510 is so good that the chip is capable of distinguishing between a soft, normal and hard keystroke even when Digitast keys are used as on the *Portable MIDI keyboard* (Ref. 1). Digitast keys have tactile feedback which makes

them quite unsuitable for providing velocity information, as is clearly explained in the relevant article (this is not to say that the *Portable MIDI keyboard* is touch-sensitive in the sense specified by the MIDI standard). The present MIDI keyboard is fully equipped for velocity processing, however, and the fact that it also uses the E510 is proof of our confidence in the chip.

Before studying the circuit and the contents of the transposition EPROM, get the right orientation by briefly looking at Fig. 2, the block diagram of the MIDI keyboard. Constructors of the *Portable MIDI keyboard* will easily recognize the general structure.

Circuit description

To avoid an unnecessary large and cluttered circuit diagram, Fig. 3 shows the (entirely theoretical) configuration of the MIDI controller with 16 keys only. The circuit diagram in fact shows only one of the possible six key decoders that may be installed. As a result of this simplification, the diagram is hardly any more complex than that of the *Portable MIDI keyboard*.

As shown by Fig. 3, each of the six key decoders is capable of addressing up to 16 key contacts, so that a maximum of 96 key contacts is available (the grand piano keyboard has 88 keys). The circuit diagram of the keyboard section in two possible versions is given in Fig. 6 (its operation will be discussed in due course).

As already stated, the basic operation of the E510 keyboard controller in the present application is similar to that in the *Portable MIDI keyboard*. Details of the key scanning mode and velocity processing are, therefore, not repeated here since these have been covered at length in Ref. 1.

The E510 has an on-board 7-bit binary counter, which provides states 0 through 127 on outputs A0 through A6. Between these outputs and the key contacts sits an

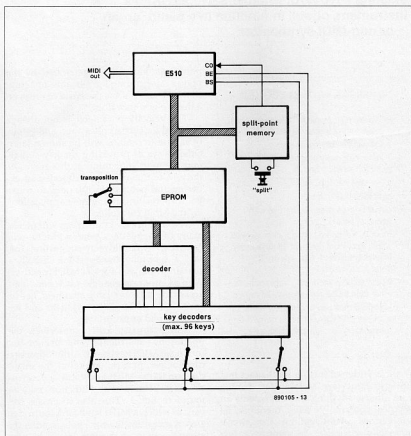

Fig. 2. Block diagram of the universal MIDI keyboard controller.

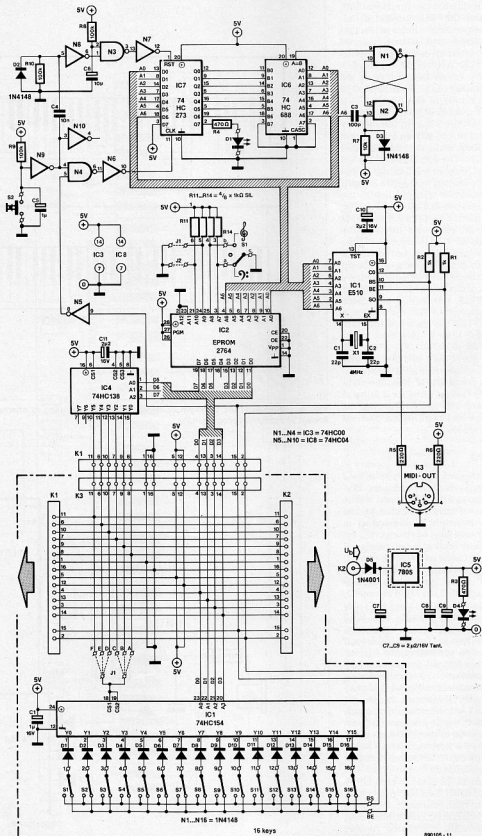

Fig. 3. Circuit diagram of the MIDI keyboard controller. For clarity's sake, only one of six 16-key decoders is shown. The configuration of the keyboard section is given in Fig. 6.

address transcoder in the form of an EPROM. This chip has two functions: first, it suppresses the E510-generated addresses corresponding to notes so low that they are inaudible, and, second, it allows the player to select up or down transposition of a section (zone) of the keyboard.

The binary values that appear at the counter outputs of the E510 are applied to the address inputs of the EPROM. The output word of the EPROM is available on 7 data lines. Of the 7 output bits, 4 carry the address of one of sixteen keys within a decoded group, and 3 the address of one of six decoders. The actual key addresses are carefully programmed values to obtain either the normal mode with no split points, or up/down transposition of the counter values supplied by the E510. The 4 least-significant data lines (LS nibble) of the EPROM are connected direct to the binary inputs of 1-of-16 decoders Type 74HCT154, which, in turn, are connected to the key contacts. The most-significant data lines of the EPROM (MS nibble) drive the address decoder, a 1-of-8 decoder Type 74HCT138, whose outputs enable the six key decoders. With the exception of the 74HCT138, the keyboard interface is basically the same as that used in the *Portable MIDI keyboard*.

The addition of the 1-of-8 decoder and some modifications to the EPROM contents make it possible to increase the number of keys to that required for a full-size MIDI keyboard. The relation between the keyboard type and the EPROM contents will be reverted to.

Split-point

Briefly, a split-point, or simply split, on a MIDI keyboard effectively splits the keyboard into two smaller keyboards, whose size in terms of keys is defined by the player. The principle is illustrated in Fig. 4. On a 6-octave keyboard, for instance, the 2 low octaves may be assigned to a bass instrument on MIDI channel 1, while the higher 4 octaves are assigned to another instrument, say, piano accompaniment, controlled via MIDI channel 2.

The top part of Fig. 3 shows the split-point programming circuit. The E510 scans the keyboard in low-to-high order, i.e., from the key producing the lowest note to the one producing the highest note. A split is simply programmed by actuating push-button S_2 simultaneously with the key that defines the wanted position of the split. This action causes the address of the key to be stored in memory. The output of the split-programming circuit pulls input CO of the E510 high while the chip scans the keyboard, and a key is addressed with a number higher than that of the key that defined the split-point. The E510 responds to the high level at CO by redirecting all MIDI data to output channel 2 rather than channel 1. When the key scanner has reached the highest key, i.e., when the E510 has passed counter state 127, the split-programming circuit is reset, and CO is made logic low again, so

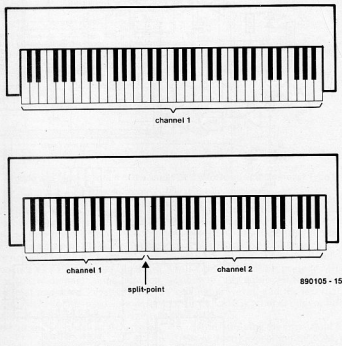

Fig. 4. Illustrating the principle of keyboard section rerouting to alternate MIDI channels, known as *split-point programming*.

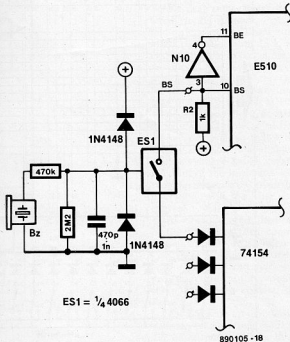
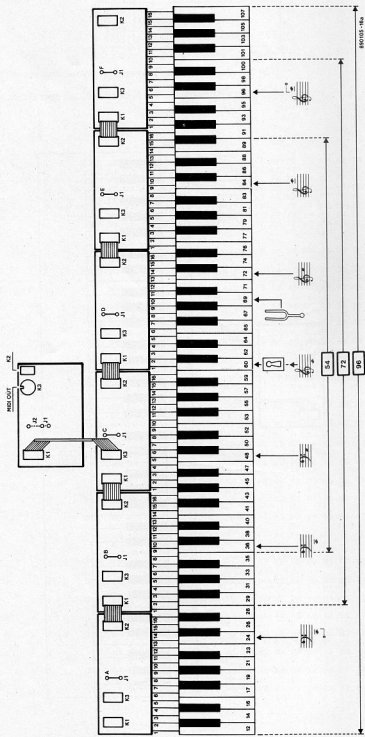

Fig. 5. Experimental percussion interface (see Ref. 2).



that MIDI data is routed to channel 1 again.

The split-programming circuit can only store a key address when line BS is low, which is the case when the pole of the addressed key reaches the work contact, and S₂ is closed. In that condition, gates N₉, N₄ and N₆ generate a positive pulse transition at the CLK input of IC₂. This octal bistable then copies the logic combination applied to its inputs, D0-D7, to its outputs, Q0-Q7. The combination forms the address of the key actuated by the player programming the split. Bit D7 does not form part of this address: it is forced logic high and causes D1 to light, indicating that a split has been programmed.

During subsequent keyboard scan cycles, IC₆, an 8-bit comparator, compares the address stored in memory and applied to its inputs B0-B6 to that available on the address bus of the E510 and applied to its inputs A0-A6. When these addresses are equal, i.e., when the keyboard scanner reaches the key that defined the split, the bistable formed by N₁ and N₂ is set to logic 1 by output A-B of the 74HCT688 (pin 9 of N₁). Input CO of IC₁ goes logic high. At the end of the keyboard scan cycle, the bistable is reset to logic 0 by the negative pulse transition on address line A6, which drives differentiator C₃-R₇-D₃.

When input CO of the E510 is low, MIDI data is routed to channel 1. When CO is high, it is routed to MIDI channel 2. At power-on, the bistable is reset to 0 by R₇-C₃. Octal latch Type 74HCT273 is also reset at power-on with the aid of a low pulse generated by R₈-C₆ and applied to the RST input. Actuation of S₂ when no key is pressed (BS is logic 1), causes network C₄-R₁₀ connected to N₈ to reset the latch also, while any previously programmed split is erased. Diode D₂ protects the input of N₂ against voltage peaks.

In practice, it is recommended to always erase an old split before programming a new one simply by pressing S₂ only.

It is possible to direct the 'low' keyboard section to the left of the split to

Fig. 6a. Configuration of an integral 96-key keyboard. Databyte 00 is loaded in the EPROM at relative address 120_H, or 0C_H counting from the start of block 180_H addresses in normal mode without transposition. A keyboard with 72 keys starting with note F may 'start' on the second contact of the second lowest decoder (selected with link B). Non-used contacts may be left open, or connected to the BE line to simulate the presence of rest contacts. In that case, the first decoder board, normally enabled by link A, need not be installed.

When it is desired to have, for example, 3 complete C-to-C octaves to the left of the middle C, the keyboard must start one octave lower at the F note corresponding to MIDI KEY 17. In that case, the board selected by link A must be installed, while the last board enabled by link F may be omitted.

A 54-key C-to-B keyboard, for instance, starts at contact S₉ of the second board.

channel 2, and the section to the right of the split to channel 1, instead of the other way around which forms the default configuration. Two possibilities exist for this modification:

- insert non-used inverter N_{10} (ICs) in the CO line (pin 12) of the E510;
- break the connection between input CO and the output of N_1 (pin 8 of ICs). Connect input CO to the output of N_2 (pin 11 of ICs) instead. This modification causes an 'unsplit' keyboard to address MIDI channel 2 instead of 1 at all times.

Inverter N_{10} in ICs is useful when the velocity parameter is to be omitted. In that case, the rest contacts of the keys need not be connected because only the work contacts are used. Indeed, the keys need not have a rest contact at all. Line BE must, however, be forced high by the actuated BS signal, and be forced low when BS is inactive. To free the BE input, remove pull-up R_1 , and connect it to the output of N_{10} , whose input is connected to BS. This modification is illustrated in Fig. 9.

Percussion enthusiasts are referred to Fig. 5, which shows an interface that allows the keyboard inputs to be driven by signals obtained from a simple beat detector built from a piezoceramic buzzer (Ref. 2).

Transposition by EPROM

The first task of the EPROM is to place the physical keyboard in the range of 128 virtual keys addressed by the E510. The controller counts from 0 to 127 irrespective of the actual number of keys connected. Without a decoder or transposition circuit, the lowest key on the keyboard would correspond to key MIDI 0. This is not very useful because this key number belongs to a subsonic frequency. The EPROM thus allows the real keyboard to be centred around number 60 of the 128 virtual keys. This centre is formed by the middle C as illustrated in Figs. 6a and 6b.

Since enough space is left in the EPROM, the complete physical keyboard can be transposed towards the low or high end of the virtual keyboard. This is the second function of the EPROM, whose available memory capacity is, however, still not exhausted. Therefore, jumpers J_1 and J_2 are provided to give access to normally unused memory in the EPROM for the implementation of special functions.

The jumpers are normally installed so that effectively the lower quarter of the

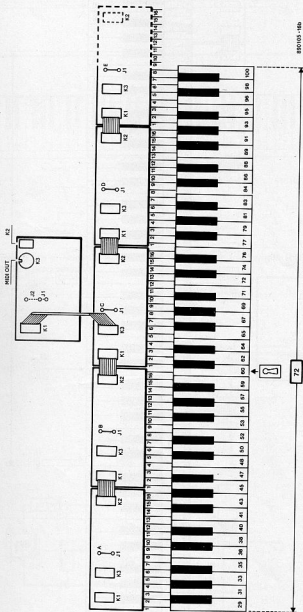

Fig. 5b. Configuration of a 72-key keyboard. The EPROM is re-programmed such that the first contact of the first decoder board corresponds to the first key of the keyboard. In normal (non-transposed) mode, databyte 00 (see Table 1) is loaded in the EPROM at relative address $1D_{H1}$, or 29_{10} , counting from the start of block 0180_{H} in Table 3 (this will be given in Part 2).

hold up to 64 different keyboard configurations. Jumpers J₁ and J₂ allow the selection of 16 different tables. The remaining 48 are available after modifying the connections of address lines A11 and A12. Electronics enthusiasts not interested in electrophonics may like to know that the E510, in conjunction with a microprocessor, is also eminently suitable for building an advanced multi-point contact scanner.

References:

1. Portable MIDI keyboard. *Elektronika* November 1988.
2. Disco drum. *Elektronika* June 1984.

The construction of the MIDI keyboard will be discussed in next month's second and last instalment of this article.

Note: the MS nibble is either 0 or an even-numbered value. The first 128 bytes are always FF. This part of the EPROM is not accessed.

0000	FF FF FF FF FF FF FF FF FF FF FF FF FF FF FF FF
0010	FF FF FF FF FF FF FF FF FF FF FF FF FF FF FF
0020	FF FF FF FF FF FF FF FF FF FF FF FF FF FF FF
0030	FF FF FF FF FF FF FF FF FF FF FF FF FF FF FF
0040	FF FF FF FF FF FF FF FF FF FF FF FF FF FF FF
0050	FF FF FF FF FF FF FF FF FF FF FF FF FF FF FF
0060	FF FF FF FF FF FF FF FF FF FF FF FF FF FF FF
0070	FF FF FF FF FF FF FF FF FF FF FF FF FF FF FF

DOWN-TRANSPOSITION (A7=1; A8=0)

*C = middle C on the first additional line under the treble stave.

0080	FF FF FF FF FF FF FF FF FF FF FF FF FF FF FF C D E F G A B C D
0090	FF FF FF FF FF FF FF FF FF FF FF FF FF FF FF E F G A B C D E F G
00A0	FF FF FF FF FF FF FF FF FF FF FF FF FF FF FF A B C D E F G A B
00B0	FF FF FF FF FF FF FF FF FF FF FF FF FF FF FF C D E F G A B *C D
00C0	FF FF FF FF FF FF FF FF FF FF FF FF FF FF FF E F G A B C D E F G
00D0	FF FF FF FF FF FF FF FF FF FF FF FF FF FF FF A B C D E F G A B
00E0	FF FF FF FF FF FF FF FF FF FF FF FF FF FF FF C D E F G A B C D
00F0	FF FF FF FF FF FF FF FF FF FF FF FF FF FF FF E F G A B C D E F G

UP-TRANSPOSITION (A7=0; A8=1)

*C = middle C on the first additional line under the treble stave.

0100	FF FF FF FF FF FF FF FF FF FF FF FF FF FF FF C D E F G A B C D
0110	FF FF FF FF FF FF FF FF FF FF FF FF FF FF FF E F G A B C D E F G
0120	FF FF FF FF FF FF FF FF FF FF FF FF FF FF FF A B C D E F G A B
0130	FF FF FF FF FF FF FF FF FF FF FF FF FF FF FF C D E F G A B *C D
0140	FF FF FF FF FF FF FF FF FF FF FF FF FF FF FF E F G A B C D E F G
0150	FF FF FF FF FF FF FF FF FF FF FF FF FF FF FF A B C D E F G A B
0160	FF FF FF FF FF FF FF FF FF FF FF FF FF FF FF C D E F G A B C D
0170	FF FF FF FF FF FF FF FF FF FF FF FF FF FF FF E F G A B C D E F G

NORMAL (A7=A8=1)

*C = middle C on the first additional line under the treble stave.

0180	FF FF FF FF FF FF FF FF FF FF FF FF FF FF FF C D E F G A B C D
0190	FF FF FF FF FF FF FF FF FF FF FF FF FF FF FF E F G A B C D E F G
01A0	FF FF FF FF FF FF FF FF FF FF FF FF FF FF FF A B C D E F G A B
01B0	FF FF FF FF FF FF FF FF FF FF FF FF FF FF FF C D E F G A B *C D
01C0	FF FF FF FF FF FF FF FF FF FF FF FF FF FF FF E F G A B C D E F G
01D0	FF FF FF FF FF FF FF FF FF FF FF FF FF FF FF A B C D E F G A B
01E0	FF FF FF FF FF FF FF FF FF FF FF FF FF FF FF C D E F G A B C D
01F0	FF FF FF FF FF FF FF FF FF FF FF FF FF FF FF E F G A B C D E F G

Table 2.

To program the EPROM:

1. Enter '0' in the cell corresponding to the number of the lowest key on your keyboard;
2. enter the successive key numbers in ascending order, right up to the highest key.

APPLICATION NOTES

Voice recorder from Texas Instruments

For many years now, the most popular means of analogue recording and playing back of audio signals has been the cassette recorder. But even here, digital techniques are beginning to make inroads. True, available material allows only relatively short recording times, but for a number of applications, for instance, telephone answering machines, advertising messages, memory aids, alarm installations, and so on, it is perfectly usable.

A new IC from Texas Instruments, the TMS 3477, is intended as basis for such equipment. Apart from RAM, all necessary functions are available on the chip. The block diagram of a possible system is shown in Fig. 1. The IC may be operated in two different ways. The simpler is by means of a four-position keyboard, of which the keys assume the functions corresponding to those normally available on a cassette recorder. The other method is via a computer. Dynamic RAMs instead of cassette tapes are used as recording medium. If you want to listen to something different, you insert a different bank of DRAMS or make a new recording.

A modified form of continuously variable slope delta modulation (CVSD) is used in the TMS 3477 for the quantization (digitization) of the audio signals. This type of modulation used with DRAMS has the important advantage of requiring only simple connections between the TMS3477 and the DRAMS.

The principle of CVSD is shown in Fig. 2. The analogue signal, u_x , is compared with u_y , a signal that increases or diminishes only slowly. Whether u_y increases or diminishes depends on u_x , which in its turn depends on the difference between u_x and u_y . The digital signal u_x thus contains information on the analogue signal. Since it is a digital signal, it may be stored in a

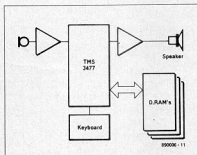
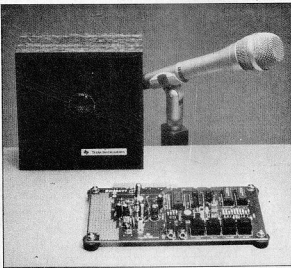

Fig. 1. A recorder system based on the TMS3477 and its block diagram.

memory.

Another advantage of delta modulation is that the integrator of the modulator may be used also as demodulator. Signal u_y then serves as the output signal.

The integrator (which is indispensable for delta modulation) is built up in the TMS 3477 rather differently from what you might expect. It is constructed from an adder and a digital-to-analogue converter. The adder is the real integrator, since, in this case, integrating is nothing more than increasing the preceding result by 1 (if u_x

is high) or reducing it by 1 (if u_x is low). The converter has been added to translate the digital content of the adder into an analogue signal, u_y , which is either fed to the comparator or, during playback, to the output.

Several of these stages may be recognized immediately in Fig. 3. First, there are the comparator, the data latch, the adder and the digital-to-analogue converter that form the delta modulator. To these are added two further integrators to enable the speed with which u_y can change is matched to the signal level. This greatly improves the quality of the sound.

The remainder of the chip consists of the necessary control logic for the external memories and the host interface via which the TMS 3477 is controlled.

An experimental circuit diagram for a complete recorder system is shown in Fig. 6. The TMS 3477 contains a mode register that defines the execution mode. This register is programmed at the power-on reset via the address outputs of the DRAMS (AP0-AP9, where AP stands for Address/Program), which serve as temporary input during the reset procedure.

Since the AP pins serve as inputs and outputs, the logic levels for initializing the IC MUST be applied via pull-down resistors (R1-R10) - pull-up resistors have already been provided on board the chip. Table 1 summarizes the functions that may be realized via these pins.

The type of RAM that will serve as memory for recording is set via pins AP0 and AP1. There is a choice of 3: TMS 4164 (64 Kbit); TMS 4256 (256 Kbit); and TMS 4C1024 (1 Mbit). Up to two RAMs (only of the same type) may be connected. Whether one or two are used is indicated via AP2.

Switches s1 and s2 further extend the

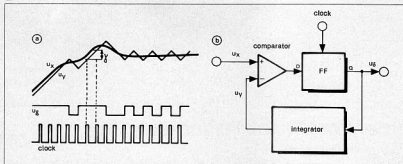

Fig. 2. The principle of continuously variable slope delta modulation (cvsd)

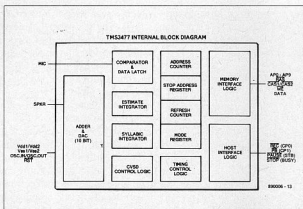

Fig. 3. Internal structure of the TMS 3477.

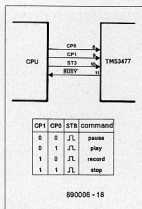

Fig. 4. One way of connecting the TMS 3477 to a computer.

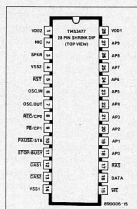

Fig. 5. Pin-out of the TMS 3477.

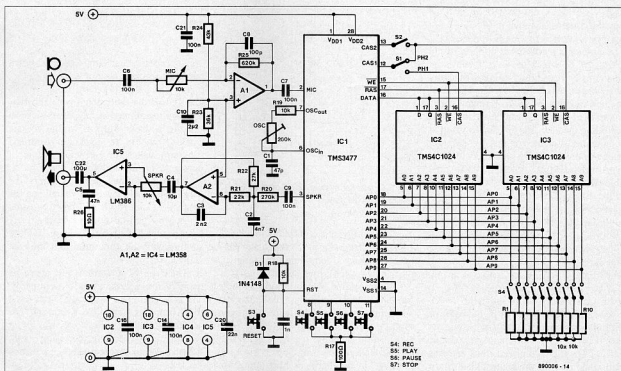

Fig. 6. Circuit diagram of an experimental voice recorder based on the TMS 3477.

possibilities of the RAMs. When S2 is open, it is possible to select either of the two RAMs by S1. This enables two different phrases to be selected—PH(phrase)1 and PH(phrase)2. With S2 closed and S1 in position PH1 (obligatory), it is possible to record and playback **one** phrase which may, however, be twice as long as either PH1 or PH2.

The next setting refers to the length of playback period. This may be given a fixed value equal to the maximum, of which more later. With variable playback period, (too long) intervals at the end of a recording may be prevented. If after a

function	address/program lines 0 1 2 3 4 5 6 7 8 9
TMS4286 DRAM	1 1 x x x x x x x
TMS4164 DRAM	0 1 x x x x x x x
TMS4104 DRAM	1 0 x x x x x x x
1 DRAM installed	x x 1 x x x x x x
2 DRAMs installed	x x 0 x x x x x x
variable playing time	x x x 1 1 x x x x
fixed playing time	x x x 0 1 1 x x x
inhibit cyclic recording	x x x x 1 x x x x
cyclic recording	x x x x 0 x x x x
keyboard-interface	x x x x x 1 x x x
CPU-interface	x x x x x 0 x x x
sample frequency 32 kHz	x x x x x 1 1 x x
sample frequency 16 kHz	x x x x x 0 1 x x
sample frequency 64 kHz	x x x x x 1 0 x x
inhibit data compression	x x x x x x 1 x x
data compression	x x x x x x 0 x x
inhibit recording monitor	x x x x x x x 1 x
exhibit recording monitor	x x x x x x x x 0

1 = no pull-down resistor
0 = with pull-down resistor
x = don't care

Table 1. The TMS 3477 contains a mode register that defines the execution mode. This register is programmed at the power-on reset via input pins AP0-AP9. These pins are also used as outputs to address the external DRAMs. The type of external DRAMs used is programmed via these pins like the mode of interfacing the chip with either a keyboard or a microprocessor. This table is used for memory and interface selection and defining the type of use of the chip.

recording the stop key is pressed, the memory address in which the last sample is stored is retained and this serves as stop address during playback later.

Another method is cyclic recording, which is set by AP4. With this method, the TMS 3477 continues recording until the stop key is pressed. Since with that method the memory will be full after a certain time, the new data is written over the old. The beginning and the end of the recording are thus "floating around" the memory as it were. The memory therefore always contains the last section of the recorded audio signal, which is useful in, say, a dictating machine.

The type of interface via which the TMS 3477 is controlled is selected by AP5. If the keyboard is selected, the voice recorder becomes a manually controlled stand-alone unit. In this application, four switches are connected to the four interface inputs. The function of these speaks for itself.

Controlling the TMS 3477 via the CPU interface offers a number of possibilities, since the CPU allows the realization of a variety of ancillary functions, such as data transmission between two voice recorders or the storing of data in a large memory with the possibility of calling up several messages on command.

Control is effected via those pins of the IC that are also used for the keyboard interface. The functions of those pins are total-

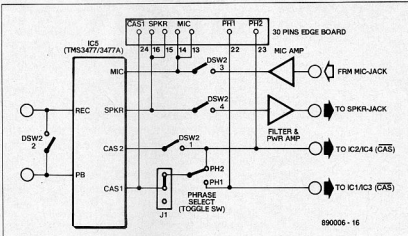

Fig. 7. Line change switches

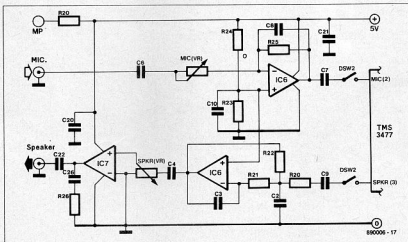

Fig. 8. Microphone and loudspeaker analogue interface.

ly different then, however. There are two Command Port lines (CP0 and CP1), a data strobe (STB) and a busy signal (see Fig. 4).

A high level on the strobe line indicates that a new command must be executed. Which demand is indicated by CP0 and CP1.

The busy signal enables the processor to check whether the TMS 3477 is in operation to prevent any unnecessary breaks in recording or playback.

The sampling frequency is set via pins AP6 and AP7. Depending on the desired quality of the sound one of three available frequencies may be selected.

The duration of playback may be calculated from the sampling frequency and the memory capacity and is

$$\text{memory capacity} / \text{sampling frequency}$$

From this relationship it follows that the minimum playback time is 1 second (64 Kb; 64 kHz) and the maximum playback time is 131 s (2 Mb; 16 kHz).

A facility afforded by the digital integrator is data compression. This, in spite of its name, is a form of expansion of the audio signal. In this mode, bits are multiplied by 4 (that is, shifted to the left by two bits) before they are applied to the digital-to-analogue converter. In this way, soft recordings are reproduced much louder, albeit with a resolution of only 8 bits. This mode can not be used when recording, therefore, because this would cause a severe deterioration of the sound quality.

The last function, recording monitor, is set via pin AP9. It enables listening in during the recording.

Finally, it should be noted that the TMS 3477 is not housed in the usual DIL package, but in one with a much smaller grid (0.070" = 1.78 mm)

Source: The "TMS 3477 solid-state voice recorder" by Philippe Clement • Texas Instruments.

IN-CIRCUIT TRANSISTOR TESTER

by A. Rigby

In electronic troubleshooting a transistor is generally not above suspicion until it responds correctly to the usual diode-tests with an ohmmeter. Before these simple test can be performed, however, the transistor must be removed from the circuit.

Experience teaches us that this operation is time-consuming as well as possibly harmful to the PCB and the rest of the circuit in a good many cases, while it offers no guarantee that the cause of the malfunction will be found.

The super-simple and inexpensive good/faulty indicator described here tests almost any transistor in circuit. A further useful feature of the tester is its built-in npn/npn indication.

The circuit shown in Fig. 1 is straightforward and based on low-cost components. The central part is a dual J-K master/slave bistable Type 4027, IC₁, of which one section, IC_{1a}, is configured as a multivibrator. The frequency of the symmetrical output signal is set to about 100 Hz by R₁-R₂-C₁-C₂. This signal is applied direct to the input of the second bistable, IC_{1b}, which supplies the transistor under test (TUT) with two complementary-phase signals, Q and Q̄, which have a frequency of 50 Hz.

In the absence of a TUT, current limiter R₅ passes a current through one of the LEDs, D₇ or D₈. These are connected in anti-parallel and light alternately because of the complementary drive signals supplied by the bistable. Because the LEDs are turned on and off at a rate of 50 Hz, they appear to light virtually constantly to the human eye.

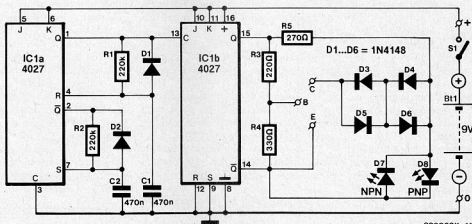
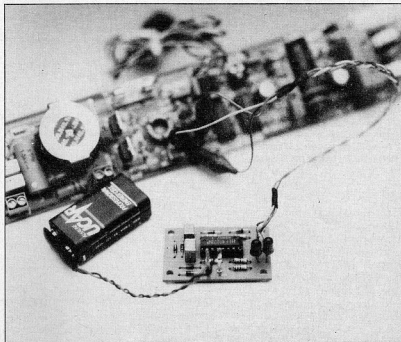

896029X-11

Fig. 1. Circuit diagram of the simple in-circuit transistor tester.

Bistable outputs Q and Q are connected to a potential divider, R₃-R₄. The voltage at junction R₃-R₄, U_{in}/2, is applied to the base of the TUT.

A correctly functioning npn TUT connected to test terminals B, C and E is switched on via D₃ and D₄ when Q is high and Q̄ low, since the base is positive with respect to the emitter. Both LEDs then remain off: D₅ because it is effectively short-circuited (the drop across an intact collector-emitter junction is about 0.1 V), and D₇ because it is reverse-biased in that condition. When the bistable toggles, however, the transistor is turned off, so that D₅ is reverse-biased, and D₇ lights. The situation is reversed if a correctly functioning pnp TUT is connected: D₅ then lights while D₇ remains off.

Spotting defective transistors

Defective transistors typically have either a short-circuited or a broken collector-emitter junction. In the first case neither diode lights because of the continuous short across them. A broken c-e junction gives the same visual indication as the absence of a TUT: the LEDs light alternately.

Diodes D₁-D₄ are included to prevent the tester giving an 'OK' indication with a transistor that has a base-to-collector or

base-to-emitter short. This leaves only one semiconductor junction in the transistor, which then acts as a diode. Depending on the logic state of the bistable, either D₁-D₂ or D₃-D₄ drop about 1.2 V, which is added to the drop across the collector-emitter junction of the TUT. A correctly functioning and conducting TUT has a typical c-e drop of about 0.1 V. Added to the 1.2 V introduced by the conducting pair of diodes, this voltage is not high enough to cause the turning on of the (red) LED that should remain off when the transistor is switched on. Therefore, only one LED lights: the indication is 'OK'. This changes, however, if the TUT has either of the above short-circuited junctions, since then the c-e drop becomes 0.6 V rather than 0.1 V. The resulting total drop of about 1.8 V (1.2+0.6 V) across the LEDs causes these to light simultaneously: the indication is 'faulty'. Summarizing the above, transistors that are good are marked by only one LED (pnp or npn) lighting. All other indications (both LEDs on or off simultaneously) point to a faulty device.

Construction

The small printed-circuit board designed for the transistor tester is populated per the Parts List and the overlay shown in

Fig. 2. The completed board is then installed in a plastic case with battery compartment. The tester is connected to the TUT with three flying wires with miniature, coloured and sleeved, crocodile clips. The 'on' push-button, npn/pnp indicator LEDs and, optionally, a transistor test socket, are mounted on to the front panel.

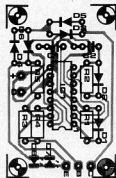
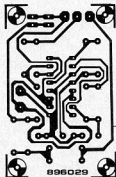
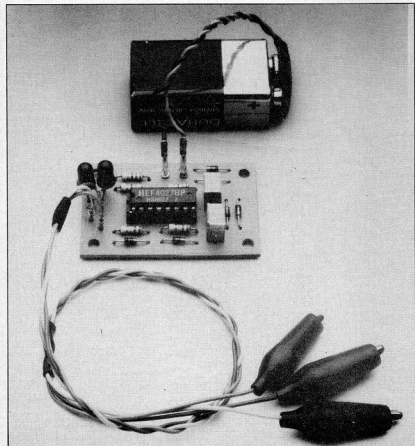

Fig. 2. True-size track layout and component mounting plan of the printed-circuit board for the transistor tester.

Parts list

Resistors (±5%):

R₁, R₂—220K
R₃—220R
R₄—330R
R₅—270R

Capacitors:

C₁, C₂—470n

Semiconductors:

D₁...D₆ incl.—1N4148
D₇; D₅—red LED; dia. 3 mm
IC₁—4027

Miscellaneous:

S₁—push-to-make button SPST.
Bt₁—9 V PP3 battery.
PCB Type 896029.

IN-LINE RS-232 MONITOR

by A. Rigby

Serial links between computers and peripheral equipment based on the RS-232 standard are notoriously difficult to get going for the first time. Much of the frustration computer users suffer while connecting-up serial equipment is caused by their inability 'to see what is going on' on the data and handshaking lines. The small in-line signal monitor discussed here largely solves this awkward problem for almost any equipment sporting an RS-232 input or output.

Connections, computer ports and cables claimed to comply with the RS-232 standard are so common these days that the original application of this serial interface is often forgotten or not even known. In computer land, it is a generally accepted fact that virtually all 'non-standard' RS-232 links — even those of the so-called 'zero-modem' type — take a lot of valuable time to get operational. Not surprisingly, it is often desired to have a simple tool available for monitoring the activity of data and handshaking signals. Before describing the operation and construction of such a tool, it may be useful to give a brief recapitulation of the basic operation of the RS-232 interface itself.

Standard RS-232: OK as far as it goes

The signals available on a RS-232 connector, whether male or female, 9-pin or 25-pin, are in principle intended only to ensure correct transmission and reception of data from so-called DTE (data

terminal equipment) to DCE (data communication equipment). A DTE is generally any data source, but it is usually a computer. A DCE is any device that converts data in a manner that allows this to be actually carried over some distance to a receiving system. The best known example of DCE is the telephone modem (*modulator/demodulator*).

The RS-232 interface is specified such that DTE is linked to DCE by wires connected to pins with the same numbers on the connectors at both sides of the cable: DTE pin 1 goes to DCE pin 1, DTE pin 2 to DCE pin 2, etc. (see Fig. 1). Similarly, the signal functions are assigned such that data transmission is optimum on this multi-wire, but essentially simple-to-make, cable (see Table 1).

DTE-to-DTE = zero-modem

All was well with the RS-232 interface until, in the early seventies, someone decided to transfer files between two computers (DTE) by hooking up their

RS-232 outlets. Such a connection between two DTE-type devices was not foreseen or, for that matter, specified or supported by the RS-232 standard, and obviates a good many handshaking signals. The so-called 'zero-modem' shown in Fig. 2 is known by now to virtually any PC user as a simple 6-wire cable (excluding ground which is not, strictly speaking carried over a wire) with one interconnection, 6—8, on each connector. In fact, the zero-modem is not a modem at all (whence its name); it merely acts as a single DCE 'seen' by both computers (DTE).

The other, even simpler, solution to DTE—DTE communication is the two-wire link, also shown in Fig. 2. Since this provides only handshaking to each individual computer, and not between the two of them, it may cause problems at relatively high data speeds. For most PCs and compatibles running the simple COPY COM1: instruction, the troubles typically start at 9,600 bits/s.

The attempts of some PC users to introduce handshaking for computer-to-com-

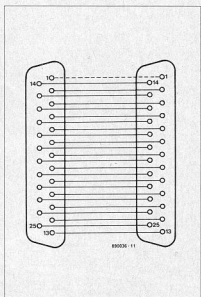
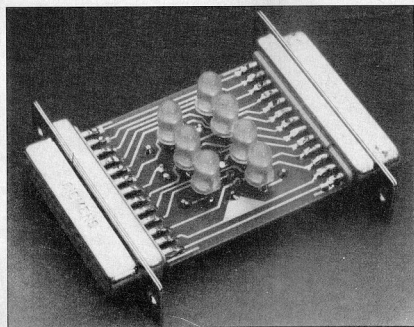

Fig. 1. Basic wiring diagram of a standard DTE—DCE 25-way RS-232 cable.

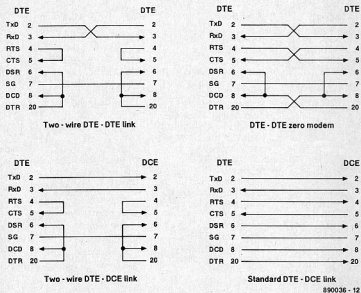

Fig. 2. Some commonly used RS-232 connections.

puter file transfer often rely on smart but essentially non-standard usage of the serial ports. Hence, these experiments are machine-specific and do not, in many cases, guarantee satisfactory results in other system configurations. Bearing in mind that the RS-232 standard is still perfectly all right for everything it was originally designed for (bidirectional communication between DTE and DCE), it is fair to argue that a good deal of the compatibility problems

experienced these days are caused by non-standard configurations and applications. By now, however, we seem to have accepted that the rapidly expanding use of computer-based communication has caused non-standard applications of the RS-232 interface to outnumber standard applications by far. So far, in fact, that the RS-232 interface is often unjustly criticized for needless complexity while used in configurations it was never designed to handle.

Examples of RS-232-based, but definitely manufacturer-specific, serial interfaces include those on PC-ATs (the famous 9-pin connector), on Postscript laser printers that can 'talk back' to the computer, on equipment sending a non-symmetrical line voltage (down to simple digital drive with +5 V), and on a host of dot-matrix printers, intelligent modems, scanners and other digitizers, all commonly used in the PC environment. Time, therefore, for a simple tool that enables the 'communication expert' to quickly locate a problem if the serial link is no great shakes.

Circuit description

The circuit diagram of Fig. 3 shows that the signal indicator is built with a number of bi-colour LEDs, associated series resistors, two connectors, and a printed-circuit board to the design shown in Fig. 4. The tracks take all 25 pins of female 25-way D-connector K₁ at one side of the board direct to the male D-connector, K₂, at the other. Seven lines between K₁ and K₂ are 'tapped' to drive bi-colour LEDs that indicate the current logic level. The seven signals thus monitored are generally considered indispensable for correct data transfer via most RS-232 links.

As to the definition of the logic levels used on RS-232 datalines, remember that a logic one corresponds to a negative voltage, and a logic zero to a positive voltage (this does apply to the control and clock lines).

Construction

The printed-circuit board is small to ensure that the RS-232 monitor is a handy

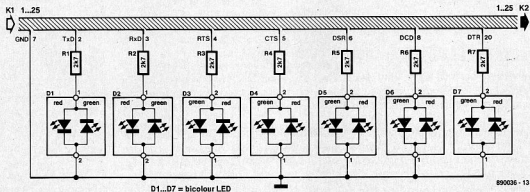

Fig. 3. Circuit diagram of the in-line RS-232 monitor. LEDs are used to indicate the status of the main signals carried via the serial link.

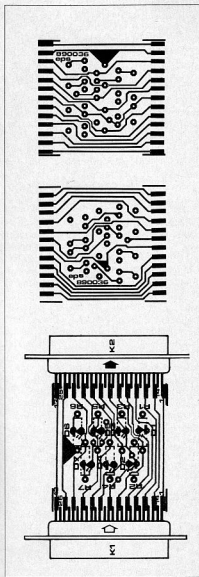

Fig. 4. Double-sided printed-circuit board for the RS-232C monitor.

Table 1.

Pin	Signal	Function	DTE	DCE
1	CG	chassis ground		
2	TxD	transmitted data	out	in
3	RxD	received data	in	out
4	RTS	request to send	out	in
5	CTS	clear to send	in	out
6	DSR	data set ready	in	out
7	SG	signal ground		
8	DCD	data carrier detect	in	out
9		positive test voltage		
10		negative test voltage		
11		not assigned		
12	SDCD	secondary DCD	in	out
13	SCTS	secondary CTS	in	out
14	STxD	secondary TxD	out	in
15	TxC	transmit clock (DCE)	in	out
16	SRxD	secondary RxD	in	out
17	RxC	receive clock	in	out
18		not assigned		
19	SRTS	secondary RTS	out	in
20	DTR	data terminal ready	out	in
21	SQ	signal quality detect	in	out
22	RI	ring indicator	in	out
23	SEL	speed selector DTE	in	out
24	TCK	speed selector DCE	out	in
25	BSY	data line busy	in	out

and rugged test device. The copper islands at the PCB edges are located in a manner that enables them to be soldered direct to the relevant pins of the 25-way female (K₁) and male (K₂) sub-D con-

nectors (these are standard types with short, straight, pins, i.e., not special PCB-mount versions).

It is recommended to fit the two bi-colour LEDs for the RxD (received data) and TxD (transmitted data) reversed with respect to the other LEDs, so that a lit green LED always indicates a logic one.

The final appearance of the RS-232C monitor depends much on individual taste. The completed board may either be cast in an ABS moulding, covered by cut-to-size metal plates, or built into an enclosure made from the hoods supplied with the D-connectors. These hoods are modified and then glued together to form a compact casing.

Parts list

Resistors (±5%):

R₁...R₇ incl. = 2K7

Semiconductors:

D₁...D₇ incl. = bi-colour LED

Miscellaneous:

K₁ = female 25-way sub-D connector.

K₂ = male 25-way sub-D connector.

PCB Type 890036

Sound future for SMT

Although there are still some who doubt the viability of Surface Mount Technology, there is ample evidence that the use of surface mount components is growing rapidly throughout the industrialized world,

None the less, there remain a number of problems of which the most serious is probably the absence of agreed international standards of assembly and inspection. Another is the difficulty of visual inspection (automated inspection systems can not — yet — take over completely from the human inspector), which stretches human capabilities to their limit (think, for instance, of the thousands of solder joints on a single Eurocard).

However, the first step to the solution of a problem is recognition of the problem and it is widely accepted that most pitfalls associated with surface mount technology have been recognized. In any case, the worldwide growth of SMT speaks for itself. If it were not a viable production method offering many advantages, it would have died a natural death by now.

SEMICONDUCTOR DIODES

by T. Wigmore

Although many readers know perfectly well what a diode is, it does no harm to repeat its definition here: it is any electronic device that has only two electrodes. There are two types of diode: thermionic and semiconductor. The present article will discuss semiconductor types only.

A semiconductor diode is basically a p-n junction, that is, a junction of n-type and p-type semiconductor material, currently usually silicon. An ideal junction of this nature, forgetting for the moment special types, such as zener diodes and varactors, behaves either as a short-circuit or as an infinite resistance, depending on the polarity of the applied voltage. Such a diode would possess differential resistance, r_d , and d.c. resistance, R_d , only. Unfortunately, ideal components do not exist and in a practical diode other parameters, such as bulk resistance, R_b ; junction capacitance, C_j ; diffusion capacitance, C_d ; case capacitance, C_c ; and terminal inductance, L , also affect its behaviour. These parameters are shown diagrammatically in Fig. 1.

The deviation of a practical from an

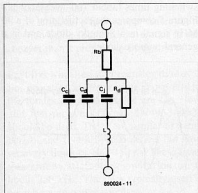

Fig. 1. Equivalent circuit diagram of a typical small-signal or switching diode.

ideal diode may be seen from the typical diode characteristic in Fig. 2. In the forward bias region, R_d is fairly large until the threshold voltage is reached, after which it is small. In the cut-off region (note the different voltage scale), only a small (leakage) current flows in the diode until breakdown occurs, after which, except in the case of zener diodes, the diode is destroyed.

Direct voltage

When the voltage applied across the diode is direct or alternates very slowly, only R_b and R_d affect the behaviour of the diode:

the other parameters in Fig. 1 may be ignored.

The diode characteristic is then a function of the two resistances only. Since we can

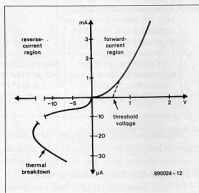

Fig. 2. Typical diode characteristic. Note the different scale of the -x and the +x axes.

not deal with the derivation of the formulas for these resistances in this article, we can only say that the threshold voltage in silicon diodes is 0.5-0.8 V and that in germanium diodes, 0.2-0.4 V. Once the threshold voltage is reached, the current would rise fast and linearly, were it not for the bulk resistance, which tends to impede the current, as can be seen in Fig. 3.

In the reverse bias region, R_b is of little significance, since it is negligibly small compared with the conductance, G_d .

The characteristic of a germanium diode is flatter than that of a silicon diode, both in the forward and in the reverse bias

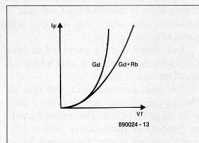

Fig. 3. Current vs applied voltage characteristic in the forward bias region with and without the effect of bulk resistance.

region.

Alternating voltage

When an alternating voltage is applied across the diode, the various capacitances inherent in the diode (see Fig. 1) become the dominant parameters. Even at low-frequency voltages, these capacitances may make the diode unsuitable for certain applications.

The relation between applied voltage, time and the consequent current through the diode is shown in Fig. 4.

The junction capacitance is important for the behaviour of the diode in the reverse bias direction, when a dense space charge exists at the p-n junction. At the instant the diode switches to reverse bias operation, the current through the junction capa-

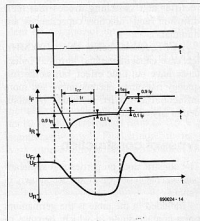







Fig. 4. From the top: the applied voltage, the current vs time curve and the voltage vs time curve.

citance changes polarity (I_F to I_R), and rapidly declines to a very low value (the leakage current, which is of the order of a few nanoamperes). The time it takes I_R to fall from 90% to 10% of the value of I_F is called the recovery time, T_r .

When the voltage rises, C_j decreases exponentially, since the width of the space charge region increases.

At zero crossings of the applied voltage, the diffusion capacitance, C_d , also affects the switching times, since the char-

Table 1

Type of diode	Construction	Properties	Applications
Alloyed junction		Large cross-sectional area of barrier layer; large capacitances; high currents; large tolerances	Power diodes; zener diodes up to 10 V
Diffused junction		Large cross-sectional area of barrier layer possible; wide range of capacitances	Power diodes; zener diodes above 10 V
Planar		As diffused junction types but with much tighter tolerances; small dimensions and capacitances possible; good HF characteristics	General purpose; zener diodes; varactors; p-n diodes; Schottky diodes; HF diodes; switching diodes
Planar epitaxial		As planar types but with very low forward resistance and very short recovery times	
Point-contact		Very small capacitances; only small currents permissible; good HF characteristics	General purpose (low reverse bias and low forward currents); HF (up to VHF region); switching diodes

ge carriers in the semiconductor material have a certain inertia and act as short-term memories, particularly when a conducting diode is switched rapidly to reverse bias operation. It is, therefore, a requirement of rectifier and switching diodes that their diffusion and junction capacitances are minimal.

At frequencies below about 100 MHz, the case capacitance and terminal inductance have but little effect, but as the frequency rises they become more and more influential and must, therefore, be included in any computations.

Types of construction

The construction, properties and applications of five types of diode are shown in Table 1.

Included in the table is the germanium point-contact diode in which, because of the very small contact area between anode (point) and the n-type germanium, the junction capacitance is very small (<1 pF) so that it is eminently suitable for high-frequency and fast-switching applications. The use of gold-gallium anodes allows switching times shorter than 1 nanosecond to be achieved. Also, its forward bias is smaller than that of silicon diodes. Against these advantages, it can not cope with currents in excess of about 10 mA.

Silicon point-contact diodes with similar advantageous properties also exist, but because of their high vulnerability to overloads they are not of great importance and are used only in very special applications.

Germanium junction diodes have been superseded almost completely by silicon junction diodes and are nowadays used only where low forward bias is vital.

Silicon junction diodes are produced principally by one of three methods. In the **alloy process**, the basic material is an n-type wafer of silicon doped with antimony into which an aluminium ball is inserted at high temperature. During the solidification process a sharply defined n-p region is formed owing to the different fusion points of the materials and the diffusion of Si atoms in the aluminium. Because of the large area of the junction, this technique ensures that large forward currents are possible, although the device parameters are subject to wide tolerances.

These tolerances are much smaller in the **diffused junction process**. In this, a wafer of n-type silicon with a very smooth surface is heated to 1300 °C in a diffusion oven after which its surface is changed to n⁺ by a P₂O₅ dopant. Subsequently, the doping layer is removed from one side of the wafer after which this is doped with boron to make it p-type.

The wafer is then provided at both sides with a terminal alloy after which it is sliced into small discs.

The cross-sectional area, and thus the ensuing capacitance, may be given a fairly wide range of values. The diffused junction process is particularly suitable for manufacturing power diodes and varactors.

Planar diodes are produced by a quite different technique. In this, a layer of sil-

con dioxide, SiO₂, is thermally grown on the surface of a silicon substrate. Photolithography is used to etch holes in the oxide layer, which then acts as a mask for the diffusion of boron impurities to produce a p-type region. The crystal is then cut into small slices. This technique guarantees small dimensions, small capacitances and precise reproducibility.

Planar epitaxial diodes have an additional n⁺ doped layer at the back which makes them extremely low-ohmic in forward bias operation.

Schottky diodes are planar epitaxial types without boron doping. Instead, they have a metal contact sintered direct on to the n-type

substrate, which (because of the Schottky effect) acts as a p-type semiconductor. This has the advantage of greater hole mobility and, consequently, a smaller diffusion capacitance and shorter storage and switching times (about 100 picoseconds). Figure 5 compares the rectification of a 30 MHz signal in a Schottky diode and in a general-purpose diode.

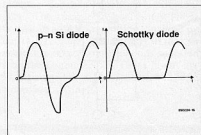

Fig. 5. The Schottky diode has definite advantages over a general-purpose diode for the rectification of a 30 MHz signal.

Practical diodes

After our short incursion into semiconductor theory, we shall now look at some practical diodes.

Small-signal diodes

The most popular small-signal diode is the 1N4148. Although this has been around for about 15 years and costs next to nothing, it has some very useful properties. With a parallel capacitance of not greater than 4 pF and a recovery time of 4–8 nanoseconds, it is eminently suitable for

use in h.f. circuits. Its family includes the 1N4149; 1N4446-1N4449; 1N914A; 1N914B; 1N916A and 1N916B, all with similar characteristics. A serious drawback of these diodes is their low forward current (max. 150 mA). Their reverse bias is of the order of 75 V and their dissipation around 440 mW. They are produced by the planar epitaxial technique.

In applications where a low voltage drop across the diode is required, the Schottky types BAT81-83 (switching time <1 ns) or BAT85-86 (switching time <4 ns) are used nowadays, where in the past germanium diode Type AA119 would have been used. The Schottky types have a lower voltage drop (<400 mV), but their reverse bias of 40-60 V is lower than that of the AA119.

Freewheeling and rectifier diodes

For mains voltage rectification at currents below 1 A, the most suitable diodes are found in the 1N4001-4007 series. Their reverse voltage, depending on type, ranges from 50 to 1000 V. Apart from the fact that all diodes in the series are easily available, and at low prices, they can withstand short peak currents of up to 30 A.

For forward currents of up to 3 A, it is best to use one of the types in the 1N5400-5406 series, which withstand short peak currents of up to 200 A.

Both series are manufactured by the planar technique.

As an aside, a full-wave rectifier configuration using four discrete diodes is still cheaper than a proprietary bridge type.

Fast freewheeling and rectifier diodes

For operation at frequencies above 50 Hz, the diodes discussed above are too slow, and fast-recovery Types 1N4933-4937 should be used. These are similar to members of the 1N4001-4005 series, but have recovery times of 100-150 ns. These times guarantee satisfactory operation up to about 250 kHz. They are typically used in switch-mode power supplies.

Still faster are the BYV36A-36E series (reverse bias 200-1000 V; t_r <100 ns); the BYV26/50-26/200 (1 A types) and the BYV27/50-27/200 (2 A types). The latter two series, all planar epitaxial types, offer recovery times of not greater than 25 ns.

High-voltage diodes

High-voltage diodes are often encountered as rectifiers in cascade circuits. Their reverse bias is high—in the BY505: 2 kV and up to 24 kV in the BY741.

Diodes with low leakage current

Diodes with very low leakage current are very hard to come by. Fortunately, they may often be replaced by good Schottky

Table 2

Type	Typical parameters	Applications
1N4148	Low forward current (200 mA; 400 mA max); fast (4 ns); inexpensive	Standard diode for small-signal and switching operation at low currents; free-wheeling diode for small relays
BAT85	Low forward current; fast; inexpensive	Schottky equivalent of 1N4148, used in inductance and millivolt meters
1N400X	Medium forward current (1 A); relatively slow; high peak currents up to 30 A	Low-frequency rectifier; freewheeling diode; suitable for mains operation
1N493X	Similar to 1N400X but faster (150 ns); 1N4937 suitable for mains operation	Fast rectifier; used in Elektor Electronics digital train decoder circuit
1N540X	Medium forward current (3 A); otherwise as 1N4001	Medium power rectifier
BYV27	Very fast switching diode (25 ns); medium forward current (2 A); low reverse bias	Freewheeling diode in stepper motor circuits; used in h.f. neon tube dimmers
BYV26	Similar to BYV27 but at higher voltage and lower current (1 A)	Used in h.f. neon tube dimmers
BYV36	Similar to BYV26 but slower	
BYV79	Fast switching diode at high currents (14 A)	Control circuits for radio control; used in 28 V converters
BYV19	Schottky rectifier at high currents (10 A)	Used in battery chargers

types or, if really necessary, by a Type BF256B field-effect transistor of which the drain and source terminals have been interconnected.

Fast power diodes

Fast power diodes are normally found in power supplies whose primary circuits are clocked and in motor control circuits. Suppressor diodes for operation at very high currents, such as the BZW86X (12-85 V at 250-1000 A; dissipation 25 kW) are not readily available and naturally tend to be very expensive.

At lower powers, the BYV79 or the

Schottky BYV19 may be used. The BYV79 is particularly suitable for use as a freewheeling diode. It can handle currents of up to 14 A, has a reverse bias, dependent on version, of up to 20 V. Unfortunately, it is not very fast (recovery time <50 ns) and has a voltage drop of 0.85 V at 10 A.

Where these aspects are important, it is better to use the Schottky version. This is not able to handle such large currents (up to 10 A), but its voltage drop of 0.6 V is significantly lower. Furthermore, its recovery time is only a fourth of that of the BYV79.

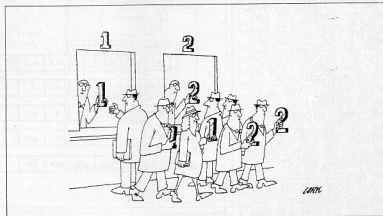

MIDI SPLIT CONTROL

A MIDI-compatible keyboard can be functionally split into a number of banks of keys with the aid of a straightforward computer program as shown below.

The MIDI SPLIT facility discussed is actually only a subroutine from a purposely developed MIDI control program written to run on a 6502-based microcomputer. As a source listing is given as part of this article, the MIDI SPLIT routine can be studied in detail by programmers whose micro allows them to write object code direct into the memory, or through an assembler. The computer should be equipped with a Type 6850 ACIA (Asynchronous Communications Interface Adaptor) programmed to send and receive MIDI data at the standard baudrate of 31.25 K. For the ACIA to operate at this data transfer rate, its clock input must be 500 kHz. A MIDI interface must, of course, be fitted at the serial I/O port of the computer.

The proposed machine language program resides in less than two pages of RAM, and may need a patch here and there to make it run on a particular system. An easily written BASIC program could be added to read the desired SPLIT POINTS.

Provided you are sufficiently well acquainted with the internal memory organisation of the micro in question—it helps when you have built it yourself—this MIDI SPLIT subroutine can offer features not commonly found on even the most expensive of programmable MIDI keyboards. To begin with, the number of split points that can be used to define the size of the banks of keys is not limited to a mere three or four; this program actually supports the use of up to *fifteen* user-definable split points. Each of the banks can be arranged to control several MIDI channels, the minimum number being *nought* (this is definitely *not* insensible), the maximum number *four*. The control of more than four MIDI channels by a single bank of keys is pro-

blematic because this lays rather a heavy claim on the accepted data transfer rate of 32 Kbaud. In essence, these 350 or so bytes turn your computer into a MIDI SPLIT PROCESSOR inserted in the data path from the MIDI keyboard to the relevant input of the synthesizer or any other MIDI-compatible musical instrument. This means that your keyboard henceforth functions as a MASTER KEYBOARD with the previously mentioned exceptional features. Importantly, the proposed program is fully transparent to the VELOCITY parameter.

Interrupts for speed

It will be understood that the proposed program must be so fast as to ensure that the data

stream from the keyboard to the instrument is not in any way slowed down. It is, therefore, hard to get round a factual implementation in an interrupt-based structure. Unfortunately, the proper dealing with interrupts is a major headache for many programmers, those resulting low spirits are often caused by the INT line in the system being low at the same time. In order to avoid difficulty arising from it being incorporated in the computer's interrupt household, the present program has been kept fairly simple and purposely does not make use of the 6502's zero-page. As shown in Fig. 2, the execution of the MIDI processing routines can be interrupted by an IRQ pulse from the ACIA, whenever its receiving register is filled with MIDI data from the

keyboard.

Before examining the program in greater detail, it is important to understand that it first filters the incoming MIDI datastream, then compares each MIDI word with entries from a table that holds information about the key numbers representing user-defined split points, and about the bank-to-channel assignment, and lastly outputs the data to the appropriate MIDI channels.

It is readily seen that the use of an intelligent data routing device sitting between a MIDI keyboard and an electronic musical instrument offers to the user a whole new scope of interesting and quite sophisticated MIDI data processing methods such as transposition, octave-shifted accompaniment, fifths and thirds, selective sup-

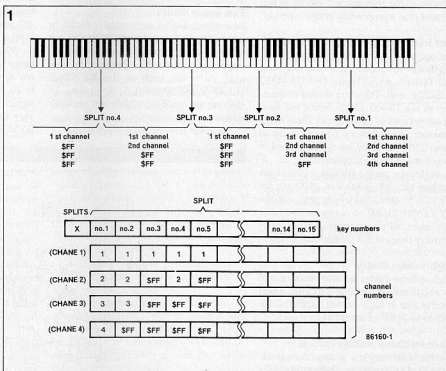

Fig. 1. An example of how split points are brought into effect to have banks of keys control specific MIDI channels.

pression of MIDI data (velocity, after touch) which would otherwise cause "partially compatible" instruments to produce undesirable sound effects, the adding of a software-implemented sustain or soft pedal, and so forth. For the moment, however, we will concentrate on the MIDI SPLIT function.

Program description

With reference to the flowchart in Fig. 2, and the source listing, Table 1, it is seen that the ACIA occupies two addresses: one for its command register (at \$E120), and one for its data I/O register (at \$E121). The CONTROL C function of the ASCII keyboard is used as the BREAK

key to enable halting the program at any time without the need for a general system RESET.

SPLITS is a variable that holds the number of desired split points, while SPLIT is the label for the 16-byte table in which the user has entered the key numbers that mark a split point.

The first entry in this table must be the rightmost split point, as shown in Fig. 1. CHANE1 is also a look-up table, but its 16 x 4 bytes are reserved for the channel numbers that go with each bank of keys defined with a set of split points. Any negative value—i.e., one greater than $7F_{16}$ —marks the end of the series of channel entries. The contents of FLAG serve the double function of *information status indicator* and *key code already received flag* ($\$80$ = key off; $\$90$ = key on; \emptyset = key number already received). IRQPNT is the pointer for the IRQ FIFO (first-in first-out) stack. KEYNMB holds the number of the key whose command is currently processed, and VELOCT is a byte that holds the corresponding key depression speed (bit-manipulation on this byte may be used to bring a software-supported *soft pedal* into action). STAT indicates whether a block of MIDI data currently processed originates from an activated or a released key. CHNCNT is a variable set up for the counting of the MIDI channel numbers that go with each bank of keys.

The Y register in the 6502 functions as a *read* vector for the IRQ stack, and must not be confused with IRQPNT which controls the *write* actions.

Begin with BASIC

The simplest method of providing for the split point and channel assignment codes in the machine language program is the running of a BASIC program that prompts the user to input his set of parameters before the actual MIDI SPLIT routine is called into action. The desired values are POKED into the appropriate address reserved for SPLITS (number of split points), the address range SPLIT...SPLIT+15 (key numbers that mark a split point), and address range CHANE1...CHANE1+63 (corresponding channel numbers). With some skill in machine language programming, a sub-routine could be written to effect the loading of a new set of parameters at the touch of a specific key on the MIDI keyboard, rather than one on the computer.

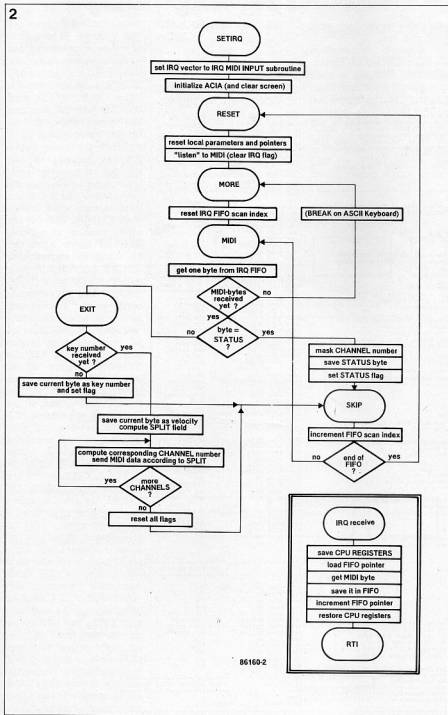

Fig. 2. This flowchart of a MIDI control program illustrates how the machine language routine on the previous page is used as the basis for further experiments in the writing of MIDI software.

```

10 ; *****
20 ; *****
30 ; *****
40 ; *****
50 ; *****
60 ; *****
70 ; *****
80 ; *****
90 ; *****
100 ; *****
110 ; *****
120 ; *****
130 ; *****
140 ; *****
150 ; *****
160 ; *****
170 ; *****
180 ; *****
190 ; *****
200 ; *****
210 ; *****
220 ; *****
230 ; *****
240 ; *****
250 ; *****
260 ; *****
270 ; *****
280 ; *****
290 ; *****
300 ; *****
310 ; *****
320 ; *****
330 ; *****
340 ; *****
350 ; *****
360 ; *****
370 ; *****
380 ; *****
390 ; *****
400 ; *****
410 ; *****
420 ; *****
430 ; *****
440 ; *****
450 ; *****
460 ; *****
470 ; *****
480 ; *****
490 ; *****
500 ; *****
510 ; *****
520 ; *****
530 ; *****
540 ; *****
550 ; *****
560 ; *****
570 ; *****
580 ; *****
590 ; *****
600 ; *****
610 ; *****
620 ; *****
630 ; *****
640 ; *****
650 ; *****
660 ; *****
670 ; *****
680 ; *****
690 ; *****
700 ; *****
710 ; *****
720 ; *****
730 ; *****
740 ; *****
750 ; *****
760 ; *****
770 ; *****
780 ; *****
790 ; *****
800 ; *****
810 ; *****
820 ; *****
830 ; *****
840 ; *****
850 ; *****
860 ; *****
870 ; *****
880 ; *****
890 ; *****
900 ; *****
910 ; *****
920 ; *****
930 ; *****
940 ; *****
950 ; *****
960 ; *****
970 ; *****
980 ; *****
990 ; *****
1000 ; *****

```

Table 1. The source listing of an experimental MIDI SPLIT CONTROL program developed for a 6502-based computer. Note that no account is taken of MIDI REAL TIME DATA, but that transposition and AFTER TOUCH are fully supported. It must also be noted that this program is not the practical implementation of the flowchart shown in Fig. 2.

MIDI SIGNAL REDISTRIBUTION

by M Eller

A versatile signal redistribution unit that facilitates interconnecting MIDI compatible instruments and control ancillaries in complex configurations.

The introduction and general acceptance of the MIDI standard have been an important incentive for owners of personal micros to process musical data from electronic musical instruments with the aid of a microprocessor. The standard MIDI interface operates on the basis of a straightforward set of musical parameters. Playing a note, for instance, entails a 3-byte command: the KEY ON code indicates the beginning of a note, but also specifies the relevant MIDI channel number; the KEY NUMBER code specifies the number of the note on a virtual keyboard, whose keys are numbered from 0 to 127 (low to high); the VELOCITY code, finally, carries information on the dynamic characteristics of the played note, which can be stopped on the instrument by once more sending the above 3 bytes, but with KEY OFF replacing KEY ON. This example illustrates the use of but a few of the many available MIDI codes. None the less, it goes to show that the MIDI command set has no provision for the definition of the duration of the note, which is simply determined by the period that lapses between the receipt of the KEY ON and KEY OFF code. There exists a system of codes to control a real-time clock for synchronizing MIDI data (a metronome function), but this provides only pulses, which must be counted to measure the duration of the notes. With or without this synchronization information, called MIDI REAL TIME DATA, it is sufficient for a microprocessor system to have a TIME function. The micro must also be reasonably fast to effect the control of one or more MIDI synthesizers, and to be able to do this on the basis of relatively simple control software. In this context, the performance of the CX5M system from Yamaha, or that of the Atari ST, can be used as a yard stick.

MIDI configurations

The majority of MIDI compatible instruments and control units have but single MIDI IN, MIDI OUT, and MIDI THRU sockets. In most cases, the signal at the THRU socket is simply obtained by reshaping and buffering the IN signal. Since the serial MIDI signal is always received in an optocoupler, phase shift and pulse distortion inevitably increase as

more instruments are series-connected to form a musical configuration. Figure 1a illustrates that the MIDI signal applied to auxiliary synthesizer no. 2 is impaired with respect to that output by the main synthesizer.

Before continuing this discussion, it is necessary to point out the different functions of the OUT and THRU sockets: the former carries signals gener-

ated by the instrument it forms part of, the second carries a duplicate of the input signal fed to the instrument it forms part of.

Figure 1b shows an alternative set-up, based on the use of a MASTER synthesizer, which is, unfortunately, only rarely spotted among MIDI compatible instruments. This device has several parallel MIDI OUT sockets, which are used for the

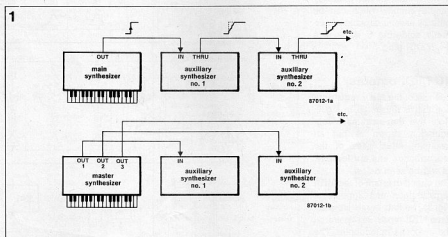

Fig. 1. This shows the advantage of a MASTER instrument over the more common IN-THRU series connection.

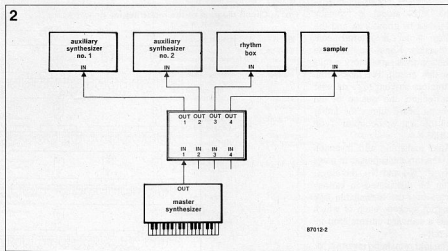
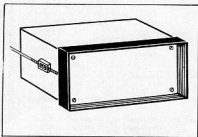

Fig. 2. The use of the MIDI UNIT ensures the absence of phase difference between the signals fed to the four instruments.

NEW PRODUCTS

INSTRUMENT CABINETS

System Engineering brings new concept to the electronic industries in the field of instrument cabinets. The instrument cabinets are suitable for standard DIN panel cutouts. These are suitable for instrumentation industries, R&D centres, educational institute, test and measuring instruments, etc. SE-44, SE-63, SE-84, SE-42, SE-33, SE-66 and SE-88 are the various instrument cabinets to suit panel cutout of 92 x 92 mm, 138 x 67 mm, 186 x 92 mm, 92 x 45 mm, 67 x 67 mm, 138 x 138 mm, and 186 mm x 186 mm, respectively. Each model is available in 80, 120, 160, 200, 250, and 300mm depth to cover entire applications.



For more details write to: **SYSTEM ENGINEERING**, • 38-39, Hadapsar Indl. Estate, • Pune, • Maharashtra 411 013
• Phone: 670962, 671951.

SMPS for B/W Television

ABR Electronics have developed six models of switch mode power supplies (SMPS) for B/W 51 cm television sets. The Series-A SMPS models have mains isolation and short circuit protection. These give the desired DC output voltages for AC input variation between 90 V and 270 VAC.

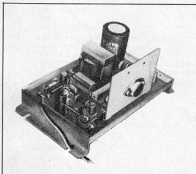

Marketing Division • ABR Electronics (P) Ltd. • Srinath Complex • First Floor
• S.D. Road • Secunderabad-500 003.

Potentiometric Strip Chart Recorder

PROTEK LM 120 R potentiometric strip chart recorder uses DC linear servomotor principle, which gives long-term reliability and comparatively better performance. The linear servomotor provides the pen-drive across 120 mm calibrated scale. The disposable pen gives a single, continuous, smudge-free trace, avoiding spreading and spilling problems. Different coloured pens are available. Plug-in chart cassettes signal of 0-10 mA or 4-20 mA as option is also available. The recorder can record almost any process variable like temperature, pressure, weight, humidity, conductivity, pH, %, or CO₂ that can be translated into an electrical signal.

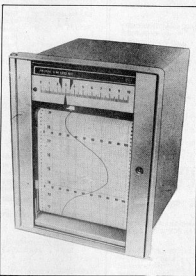

M/s. Protek Instruments Pvt. Ltd. • 88/3, Parvati • Janaki Apartments • Chintamaninagar • Sahakarnagar No. 2 • PUNE-411 009.

Ioniser & Air Purifier

THE Ioniser and air purifier can be used to clean the air of pollution and balancing the positive and negative ions percentage in the air. Negative ions work as "AIR VITAMINS" and can give relief to ASTHMA PATIENTS as well as allergic patients. The Ioniser can be used in bed rooms, Kitchens, drawing rooms,



offices, hospitals, operation theaters, factories etc. The unit is enough for a room size of 1500 cubic feet. It works on 230 VAC and power consumption approximately 1.5 W per hour.

M/s. Prayag Electronics • A-5, Success chambers • 1232, Apte Road • Deccan Gymkhana • PUNE-411 004.

Time Switch

THE MIL 2008 Q series is fitted with a quartz electronic drive control and a step motor. The quartz frequency is 4.19 million Hertz and the quartz stabilisation ensures the exact running of the driving mechanism. These time switches are designed for the accurate and effortless control of oil heating installations, electric heaters, airconditioning plant, water processing plant, street lights, traffic signals, etc. MIL 2008 Q is available with contact rating of 16 A, 250 VAC and with daily programme and weekly programme dial. It operates on mains supply and continues to run for 150 hours after power failure on a battery back-up.

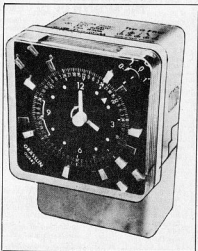

M/s. Sai Electronics • (In association with cupwud Arts) • Thakore Estate • Kurla Kiroli Road • Vidyavihar (West) • Bombay-400 086. • Ph: 5136601/5113094/5113095.

resistance, eliminates errors due to leads.

7 mm LED display and operates on 230 V \pm 10%.

Temperature Programmer

SCR Elektroniks has developed a temperature programmer, the Model Step Prog-8, for use in any industrial or research process requiring accurate temperature control at different temperature setting levels for pre-determined times. Eight levels could be set at the beginning of the process. Similarly corresponding time periods can be set for each temperature level.

The accurate temperature is indicated on digital temperature indicator. The step-in progress is indicated on LED marked Program number. The temperature setting of that step can be read on digital display by pressing "Press to read" Pushbutton. The facility to actuate an alarm for lower or higher temperature is optionally available and a delay timer is provided to silence (mute) the audio alarm for a period settable with knob (potmeter).

Battery back-up is provided to maintain the programme and the current step in fact in the event of power failure.

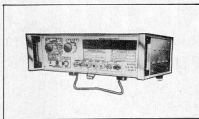

M/s. Vasavi Electronics • (Marketing Division) • M7 & 8, Chenoy Trade Centre • Park-Lane • Secunderabad-500 003. • Phone: 70995.



Agrawal Sales Enterprises • 34, Ganesh Bazar • Jhansi-284002 (U.P)

Digital Time Interval Meter

PLA digital time interval meter has a measurement range of from 1 m sec to 9999.9 sec. Its 4 or 5 digits LED display gives high accuracy for smallest time interval measurement of 0.1 m sec. It has a provision of measuring time interval in 16 different modes.

The Time interval meter is used for measuring Switching time of relays, trip time and On time of circuit breaker, having time of fuse element, travel time of switch and contractor, etc. It can be used for measuring the time interval by step positive (2 V to 5 V DC) Voltage application/removal mode.

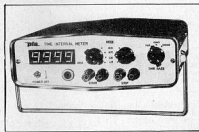

M/s. Pla Electro Appliances Pvt. Ltd. • Thakor Estate • Kurli Kirol Road • Vidyavihar (West) • Bombay-400 086. • Ph: 5132667/5132668/5133048.

Soldering Station

The Model DAA-IO soldering station features a temperature sensing element positioned at the tip of the soldering iron which continuously senses the temperature at the iron tip and sends corresponding signal to operate the relay supplying to the heater element. The heater of operates with regulated 24 VDC stepped down from 230 VAC 50 Hz through an isolation transformer. The iron tip is perfectly grounded for the safety of the components which are to be removed. The unit is suitable for soldering components like ICS, CMOS etc.

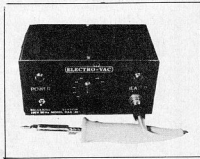

M/s. Electro-Vac • IO/430-431 • Tasveer Apartments • Soni Falia • Panini-bhint • Surat-395 003.



M/s. SCR Elektroniks Opp. Fatima High School • Kirol Road • Vidyavihar • Bombay-400 086. Tel: 5134605/5128057.

Digital LCR Meter

INDUCTANCE, Capacitance and Resistance measurements can be done by the Vasavi Digital LCR Meter by eliminating bridge balancing. Display of Simultaneous Tan Delta (dissipation factor) facilitates checking the quality of the component. The ranges covered are 0.0001 ohm to 20 Mohm, 0.1 pF to 20,000 mF, and 0.1 micro Henry to 2000 Henry. For 10w capacitance measurement Guard Terminal is provided to eliminate measurement error due to stray effects. Four Terminal measurements for large capacitance and very low

Opto Digital Capacitance Meter

OPTO Digital capacitance meter incorporates high quality integrated circuits so that reading is not affected by the capacitor leakage current. The instrument has various ranges to measure different values of capacitors with 3½ digit

NEW PRODUCTS

Plug-In Modules & Instrument Cases.

EUROPACK have developed what is said to be a new concept in 19" plug-in units (sub-racks) and bench top model instrument cases. These cabinets are of sturdy frame construction, using aluminium extruded sections. The Ms cover plated are inserted through the slots in the depth extrusion. The handles are designed to take heavy loads. Four feet give the bench case facility, which the two front feet have tilt facility. Special dies give ventilation slots. No screws are visible on the cabinet except 4 Nos. On the rear panel, covered by moulded plastic washers which also act as legs. These cabinet also can be made as per IP53 specifications.

The standard heights are from 2 U to 9 Us (1U-44.45 mm). The standard depths are from 150 mm to 500 mm in multiples of 50 mm. The standard widths of the bench cases are 84 TE, 63 TE, 56 TE, 42 TE, 28 TE, and 21 TE (1 TE = 5.08 mm). Apart from the standard sizes, cabinets can also be made as per requirements from standard components.

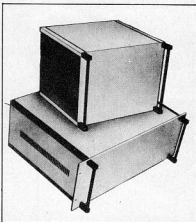

M/s. Europack • C/10, Laghu Udyog Kendra • 1B, Patel Road • Goregaon (E) • Bombay-400 063.

Inductive/Capacitive Proximity Sensors

HANS TURCK GMBH & Co. KG (federation Republic of Germany) manufacture inductive proximity switches with sensing distance of 60 mm, and capacitive proximity switches of 10-40 mm.

Special proximity switches are available for explosion, welding pressure and high temperature-proof applications. Other products are motion control gear, including rotational speed monitor, rotational speed meter, speed sensor and direction discriminator. These device also monitor other repetitive movements.

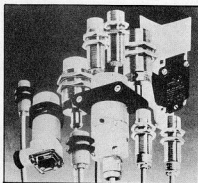

M/s. Arun Electronic Pvt. Ltd. • 2 E, Court Chambers, • 35, New Marine Lines • Bombay-400 020. • Tel: 252160/252907.

Digital Line Frequency Meter

ANU Viduyt Digital Line Frequency Meter Type 321 is for measuring line frequency in power plants, sub-stations, distribution centres, etc.

High accuracy and long term stability is made possible by incorporating a crystal controlled clock generator. The measuring frequency frequency remains 50 Hz to 99.99 Hz with accuracy of ± 1 digit, operating voltage in range of 180 V - 280 V AC single phase.

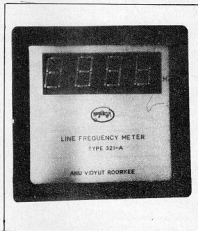

A clear 25 mm LED display clearly indicates the frequency. The instrument is lightweight and suitable for panel DIN 144 mounting i.e. panel cut-out to be 135 x 135 mm; also available in DIN 96.

Anu Viduyt • C-1, Industrial Estate • Roorkee-247 667.

TOTALISER

JELTRON offer the Model 810A microprocessor based digital indicator-cum-totaliser suitable for a variety of industrial applications. The front panel consists of four-digit LED display alongwith a user friendly membrane keyboard. The totaliser based on 6502 microprocessor, can be used areas like bas and liquid flow totalising, KW hour, totalising and so on. Engineering units i.e. litres/hour, litres/minute, decimal point positioning for ranging, and totalising update time are all programmable through front panel keyboard.

The totaliser accepts an analog input signal of either 0 to 5 VDC, 0 to 10 VDC 4-20 mA current, or millivolts input. At any given time the totalised output can be seen by using the front panel keyboard. Similarly it can also be reset using the front panel keypad.



M/s. Jeltron Instruments (India) Pvt. Ltd. • 6-3-190/2, Road No. 1 • Banjara Hills • Hyderabad-500 034.

NEW PRODUCTS

Illuminated Magnifying Glass

MARVEL Products offer the M-Plast illuminated magnifying glass for engineers, scientists, type-setters, finger print experts, proof readers, bankers, artists, hobbyists etc. The 23 cm long plastic moulded body has 9 cm round magnifying glass. Hi-beam light can be switch operated. It works on four 1.5 V penlite batteries.

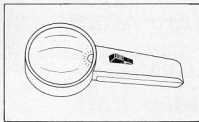

M/s. Marvel Products • 208, Allied Indl. Estate • Mahim • Bombay-400 016. • Phone: 468346/466846.

Emergency Lamp

EL 636 is a portable emergency lamp fitted with 8" fluorescent single tube, and the automation is fully electronic. The storage cell is maintenance free, and the body is of fibreglass reinforced plastic. The lamp can continuously work for three hours. Built-in inverter is heavy duty, long life. Dimensions are H-9", L-2.5", D-4", and weight 1.4 kg.

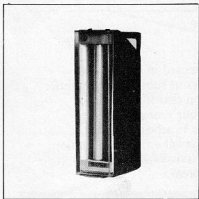

M/s. Trivandrum Electronics • (Marketing Division) • 26/571, Oottukuzhy • Trivandrum-695 001.

Electronically Temperature Controlled Soldering Bath

An Electronically controlled tinning bath suitable for uniform and perfect tinning of delicate electronic components has been developed. It works with input voltage of 230 V \pm 10% with output voltage of 0.75 KVA. The Temperature can be set between 170° and 350°C. The capacity of the bath will be around 500 C.

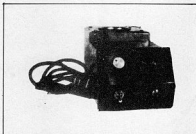

M/s. M.R.K. & Brothers Engineers • 310 A, Commence House • N.M. Road • Fort • Bombay-400 023.

Electronic Conveyor Belt Weigher

ENCARDIO-RITE's Model ECBWS-101 Weightoveyor is a precision electronic conveyor belt scale designed to continuously weight any bulk material that can be conveyed, indoor or outdoor in dusty or wet environment. It is constructed from heavy duty structural steel to permit complete torsional stability. The design brings the total sensed weight to a single point so that it can be monitored by a precision strain gage type of load sensor, Encardio-Rite's Model EAU-310 load cell. The Weightoveyor offers an accuracy of \pm 0.25% fsd for 4 idler systems, and \pm 0.5% fsd for 2 idler systems.

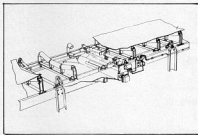

M/s. Encardio-Rite Electronics (P) Ltd. • A-5, Industrial Estate • Talkatora Road • Lucknow-226 011 (India) • Tel: 50382, 52130.

Moisture Meter

OPTO 1100 M Series of portable moisture meters is for quick and accurate determination of percentage moisture contents of organic and inorganic materials as well as hygroscopic materials, such as timber, soil, cotton, grain etc. The instrument operates on pencil battery cell or DC power supply.

The results are independent of any variation in ambient environmental conditions.

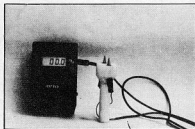

Agrawal Sales Enterprises • 34, Ganesh Bazar • Jhansi-284 002.

Capacitor Holder

NOVCFLEX have developed a one-piece holding device for fixing and holding aluminium can type electrolytic capacitors. Application is simple:- just position it on the capacitor and press the jaws together. For maximum tightness a plier can be used to give that little extra firmness and vibration resistance. By applying lateral pressure, the snapper capacitor holder can be easily released and reused again and again. The holder is made from high engineering thermoplastic polyamide displaying high strength, toughness, flexibility, excellent abrasion resistance and good electrical insulation.

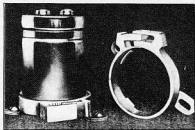

M/s. Novoflex Cable Care Systems • Post Box No. 9159 • Calcutta-700 016 • Tel: 29-4382, 29-5939, 29-3991.

Precision Digital Multimeter

PREMA (Prazision Electronic und Mess Anlagen GmbH) of Fed. Republic of Germany offer seven high accuracy 6½-digit resolution DMMs in a range. The top-of-the-line-DMM 6031 A has a ohms stability of 2 ppm for 24 hours, and accuracies of 0.07% for AC volts, 0.005% for DC and 1% for AC currents. Temperature tolerance is 0.05°C IEEE 488 bus interface is a standard feature. DMM 6031 A has a 10 gigaohm input resistance. A series rejection of more than 100 dB is attained because of the inherent advantages of PREMA's patented multiple ramp integration synchronised by PLL to the mains frequency, and advanced shielding techniques. The DMM can be fitted with an inbuilt 20 channel 4 pole scanner (thermal offset 1 μ V) for use in multi-point measuring systems. It has a wide scope of data processing operations on the measured values using its set of 20 mathematical programs. Functions include 8th order polynomial linearisation, non-linear, trigonometric, and statistical functions, etc. Up to four programs can be cascaded in any desired sequence to give a new compound program.

over-range indication. The unit is housed in an elegant moulded cabinet and weighs less than 1.5 kg.

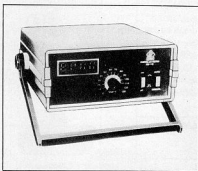

M/s. Puneet Industries • H-230, Ansa Industrial Estate • Saki-Vihar Road • Bombay-400 072 •

Stroke Counter

CE Industries offer the 5 digit stroke counter model No. CSO30 with large display. A knob reset facility brings all the figures to zero. No lubrication is required as all the moving parts are made of self-lubricating material. The counter is used for printing presses, duplicating machines, circuit breakers, power presses, injection moulding machines, etc.

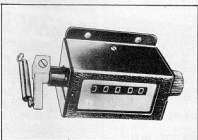

M/s. Sai Electronics • (A Divn. of Starch & Allied Industries) • Thakor Estate • Kurla Kiron Road • Vidyavihar (West) • 400 086 • Ph: 5136601/5113094/5113095

In-Circuit Tester

Kandenstu Ltd. of Japan, offer the Fussa, Cabol 3301, a parts mounted board tester that helps accomplish three critical functions viz. precision in measurement, test speed and analog isolation, in a well balanced manner. The 3301 offers 320 test points, expandable to 1024, in steps of 32 points. Measuring speed for short test is 3 seconds/320 pin.

Maximum measuring steps are 2048 (each measuring step tests a component) at the speed of 15 ms per step. COBOL 3301 features automatic guarding facility which not only simplifies complex measurements but also uprates the measurement precision. The maximum number of guarding points for each test step is 15 with guarding points for each test step is 15 with guarding current as high as 100 mA. The measuring range for Cobol 3301 covers, resistance 0.1 ohm to 100 Mohm, capacitance 1 pF to 100,000 mF, inductance 1 uH to 100 H, diode and transistor 0.1 V to 2.0 V and Zener Diode up to 40 V. Applicable PCB measurement is 450 mm x 350 mm (maximum). The Fussa Cobol3301 range consists of: Gorilla for press type fixture, Elephant for vacuum type fixture, and Dragon automatic feed in-circuit board tester.

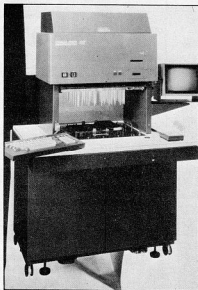

HCL Limited • Instrument Division • G-5 & 6 Vaikunth • 82-83 Nehru Place • New Delhi-110 019 •

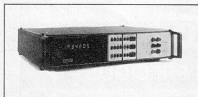

Electronics Engineering Services • 231 Keytuo Industrial Estate • Kondivita Road • Andheri (East) • Bombay-400 059 •

Digital pH/mV Meter

Puneet 3½ digit PH meter model No. PH-11D is a LED type portable instrument for laboratory R&D, and educational institutions. It has extremely stable DC amplifier with high input impedance. It provides manual and automatic temperatures compensation in the range of 0°C to 130°C. It has asymmetry and slope correction controls for periodic calibration. It also provides recorder output and titration facilities. It measures pH from 0 to 14 and mV from 0 to \pm 1999 mV with automatic polarity and

CORRECTIONS

Pitch control for CD players

January 1989.

On the component overlay of printed-circuit board 880165 (Fig. 7), the capacitor next to C₂₁ should be marked C₂₀, not C₁₅. The value remains the same at 100 nF, but a ceramic capacitor should be used as advised in the Parts List.

Colour test-pattern generator

January 1989.

Diodes D₁₆, D₁₇ and D₁₈ are shown with the wrong polarity on the component overlay shown in Fig. 5.

Autonomous I/O controller (part 1)

January 1989.

Table 1 should be inverted: no diodes fitted gives instrument address 150-151, and both diodes fitted address 144-145.

The digital model train (part 1)

April 1989.

In some cases the operation of the locomotive decoder is affected by points control commands. This problem can be solved by increasing the value of R₁ from 12 k Ω to 39 k Ω . The circuit diagram (Fig. 16) should be amended accordingly.

LFA-150: a fast power amplifier (final part)

January 1989.

On the component overlay of the protection board shown in Fig. 10, the plus sign at the negative pole of electrolytic capacitor C₁₈ should be removed: the printed capacitor symbol indicates the correct polarity.

**ENSURE
YOUR COPY
AT YOUR
DOORSTEP**

Please send this form duly filled with your payment for subscription

Subscription to **elektor** INDIA
is accepted from the current issue

INDIA

1 Year Rs. 85/- 2 Years Rs. 160/- 3 Years Rs. 230/-

OVERSEAS 1 Year ONLY BY AIRMAIL Rs 425/-
(SOUTHEAST & SOUTHWEST ASIA ONLY)

Enter details on both sides of this form

NEW/RENEWAL SUB No.	PERIOD.....YR/S	RS.
-----------------------------	-----------------	----------

CHEQUE/D.D./M.O. No.	DATE
---------------------------	------------

Payment to: **Elektor Electronics Pvt Ltd** Add. Rs 10/- for outstation cheques

Elektor Electronics Pvt Ltd
52-C, Proctor Road Grant Road (E) Bombay-400 007

Get the ECIL advantage!

Tap the dedicated design group
to develop the working hybrid
you need

Besides the size and weight reduction for enhanced portability, Hybrid Microcircuits free you from chores involving layout design, procurement of components, inspection, inventory planning, population and final testing. A series of steps that invariably go into the making of a microcircuit.

ECILs dedicated design group aided by CAD facility can help you develop the working hybrid you need. Be it in telecommunications or computers or what have you.

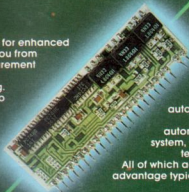

The manufacturing facilities are about the best anywhere: High speed screen printing machines, computerised automatic laser trimming system, high-speed automatic pick and place system, automatic functional testing equipment, etc. All of which add up to give you the advantage typically ECILs. Technical or commercial.

ECIL Hybrid Microcircuits

For enquiries, contact:
Marketing Manager, Sales II

इंफो ECIL

इलेक्ट्रॉनिक्स कॉर्पोरेशन ऑफ इंडिया लिमिटेड
Electronics Corporation of India Limited
(A Govt. of India — Dept. of Atomic Energy — Enterprise)
Components and Special Products Group
Hyderabad-500 762
Phones: 850131 Extn: 258, 853831
Telex: 0425-7059

A39/ECIL/88111